

客户端接口

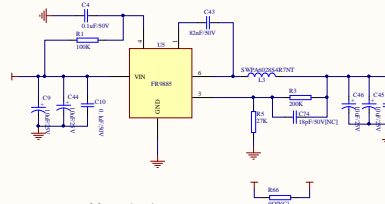

12V转5V电路

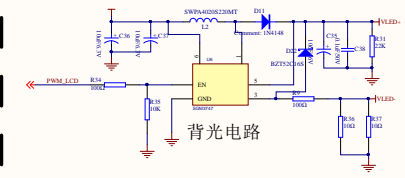

背光电路

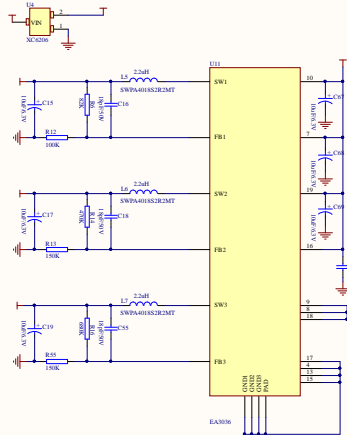

电源管理电路

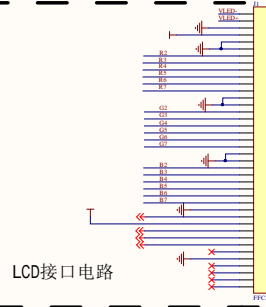

LCD接口电路

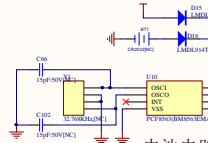

电池电路

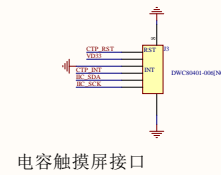

电容触摸屏接口

RS232/TTL转换电路

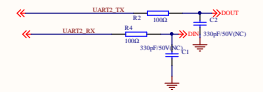

电阻触摸屏接口

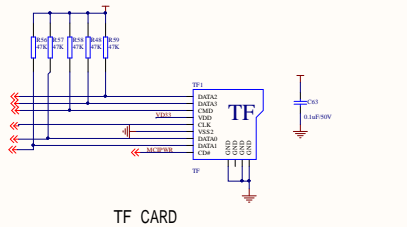
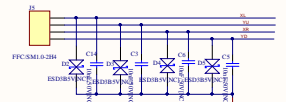

TF CARD

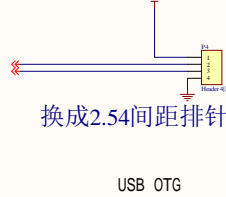

USB OTG

换成2.54间距排针

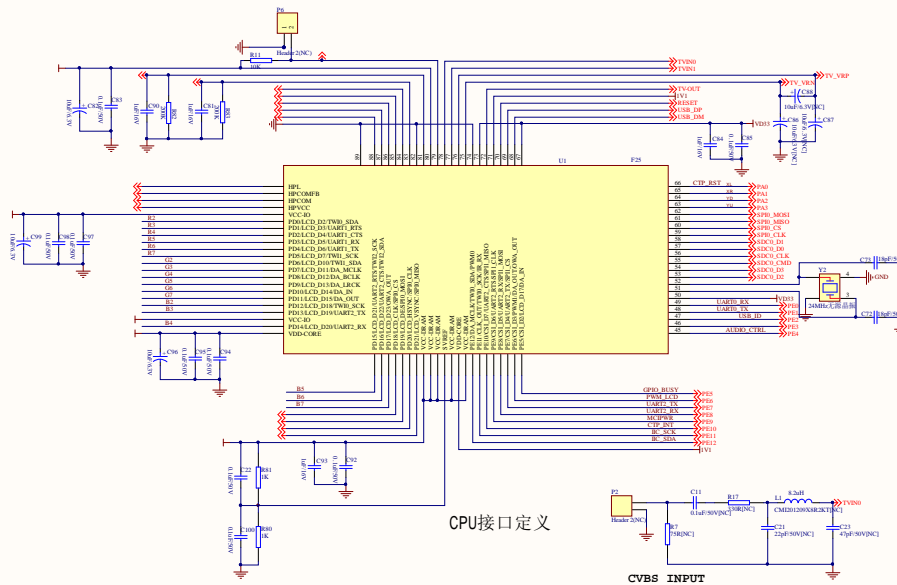

CPU接口定义

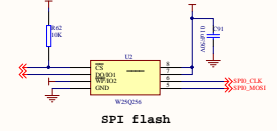

SPI flash

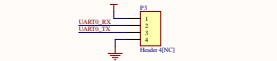

DEBUG

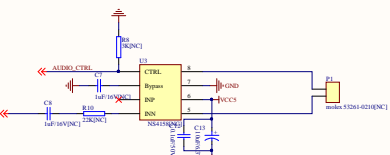

增益GAIN:  $A_v = 360K / (10K + R_i)$

音频电路

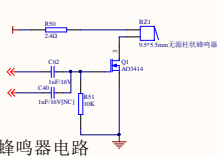

蜂鸣器电路

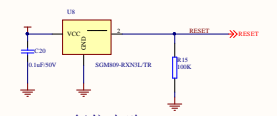

复位电路

KEYS

Time	Number	Revision
01	1.0	Initial
02	1.1	Update
03	1.2	Update
04	1.3	Update
05	1.4	Update
06	1.5	Update
07	1.6	Update
08	1.7	Update
09	1.8	Update
10	1.9	Update
11	1.10	Update
12	1.11	Update
13	1.12	Update
14	1.13	Update
15	1.14	Update
16	1.15	Update
17	1.16	Update
18	1.17	Update
19	1.18	Update
20	1.19	Update
21	1.20	Update
22	1.21	Update
23	1.22	Update
24	1.23	Update
25	1.24	Update
26	1.25	Update
27	1.26	Update
28	1.27	Update
29	1.28	Update
30	1.29	Update
31	1.30	Update
32	1.31	Update
33	1.32	Update
34	1.33	Update
35	1.34	Update
36	1.35	Update
37	1.36	Update
38	1.37	Update
39	1.38	Update
40	1.39	Update
41	1.40	Update
42	1.41	Update
43	1.42	Update
44	1.43	Update
45	1.44	Update
46	1.45	Update
47	1.46	Update
48	1.47	Update
49	1.48	Update
50	1.49	Update
51	1.50	Update
52	1.51	Update
53	1.52	Update
54	1.53	Update
55	1.54	Update
56	1.55	Update
57	1.56	Update
58	1.57	Update
59	1.58	Update
60	1.59	Update
61	1.60	Update
62	1.61	Update
63	1.62	Update
64	1.63	Update
65	1.64	Update
66	1.65	Update
67	1.66	Update
68	1.67	Update
69	1.68	Update
70	1.69	Update
71	1.70	Update
72	1.71	Update
73	1.72	Update
74	1.73	Update
75	1.74	Update
76	1.75	Update
77	1.76	Update
78	1.77	Update
79	1.78	Update
80	1.79	Update
81	1.80	Update
82	1.81	Update
83	1.82	Update
84	1.83	Update
85	1.84	Update
86	1.85	Update
87	1.86	Update
88	1.87	Update
89	1.88	Update
90	1.89	Update
91	1.90	Update
92	1.91	Update
93	1.92	Update
94	1.93	Update
95	1.94	Update
96	1.95	Update
97	1.96	Update
98	1.97	Update
99	1.98	Update
100	1.99	Update
101	2.00	Update

1.Part Number	2.Name	3.Description	4.Value	Designator	Quantity
				B11	1
				B21	1
				C1, C2	2
				C3, C5, C6, C14	4
				C4, C10, C20, C22, C38, C47, C63, C78, C83, C85, C91, C92, C94, C95, C97, C98, C100	17
				C7, C8, C40	3
				C9, C44, C45, C46	4
				C11, C12, C25, C64, C65	5
				C13, C86, C87, C88	4
				C15, C17, C19, C36, C37, C67, C68, C69, C77, C82, C96, C99	12
				C16, C18, C55, C72, C73	5
				C21	1
				C23	1
				C35	1
				C43	1
				C56, C62, C81, C84, C90, C93	6
				C66, C102	2
				C74	1
				D2, D3, D4, D5	4
				D11	1
				D14	1
				D15, D16	2
				D22	1
				J1	1
				J2	1
				J3	1
				J5	1
				L1	1
				L2	1
				L3	1
				L5, L6, L7	3
				P1	1
				P2, P6	2
				P3, P4, P5	3
				Q1	1
				R1, R12, R15	3
				R2, R4, R9, R34	4
				R3, R82, R83	3
				R5	1
				R6	1
				R7	1
				R8	1
				R10	1
				R11, R35, R51, R62	4
				R13, R55	2
				R14	1
				R16	1
				R17	1
				R28	1
				R31	1
				R36, R37	2
				R48, R56, R57, R58, R59	5
				R50	1
				R52, R53	2
				R66	1
				R80, R81	2
				IF1	1
				J1	1
				J2	1
				J3	1
				J4	1
				J5	1
				J6	1
				J8	1
				J10	1
				J11	1
				Y1	1
				Y2	1