

NB-IoT开发板 EVB_M1 原理图 (BC95+STM32L431RxT6) 物联网俱乐部

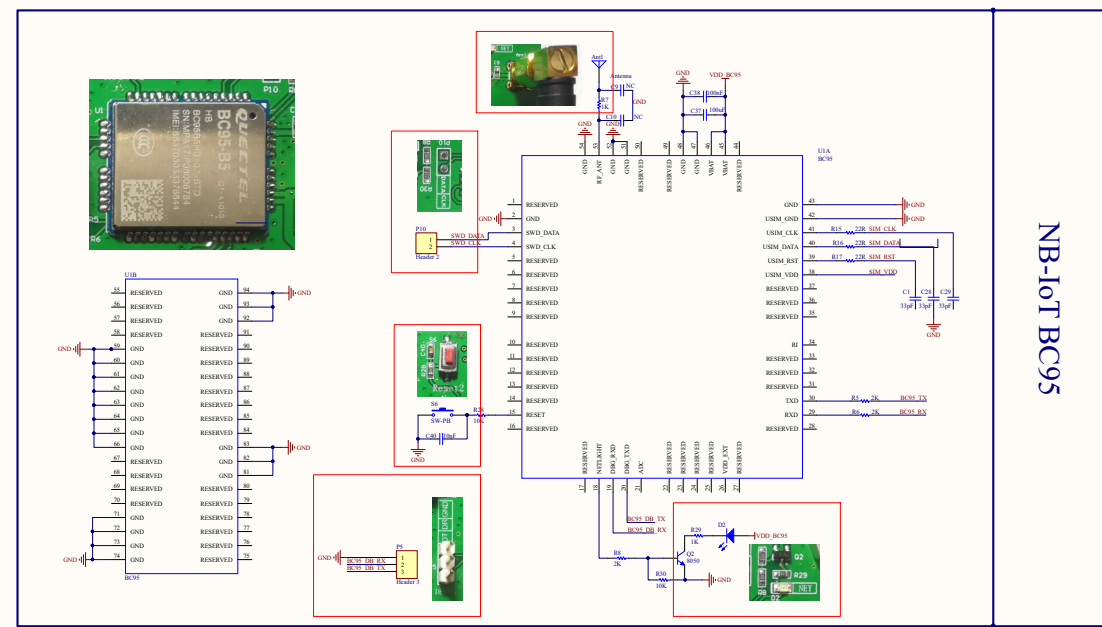

NB-IoT BC95

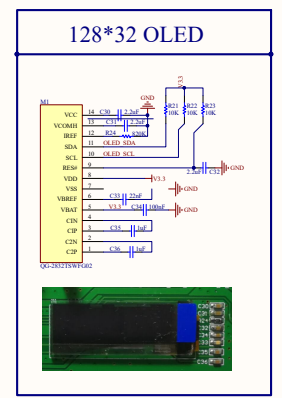
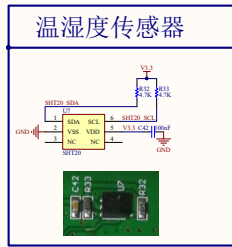
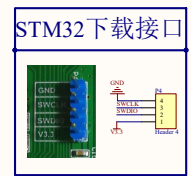
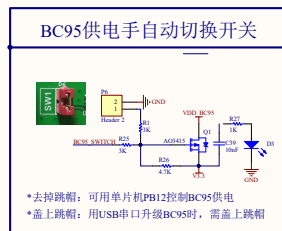
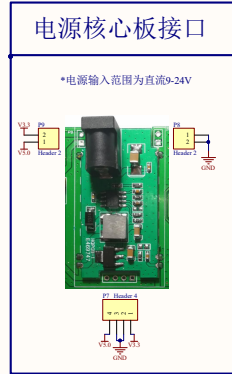
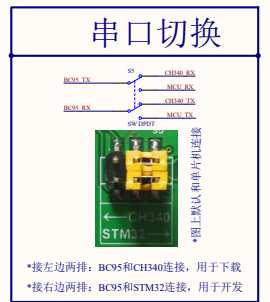
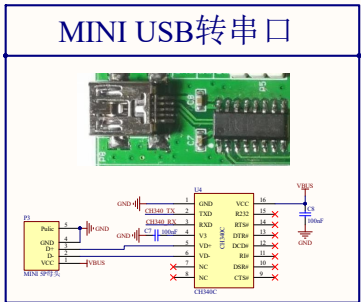
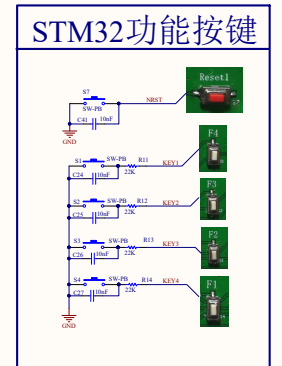
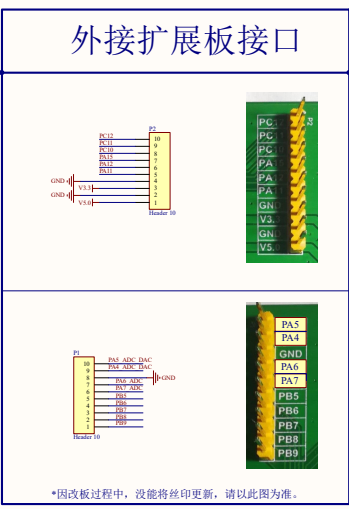
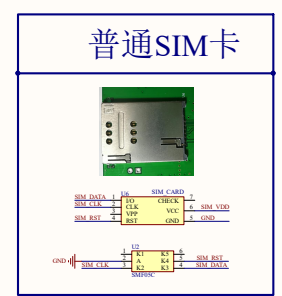
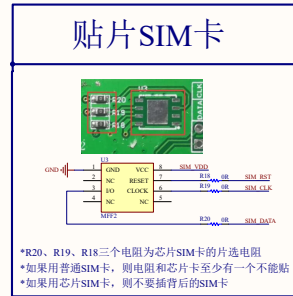
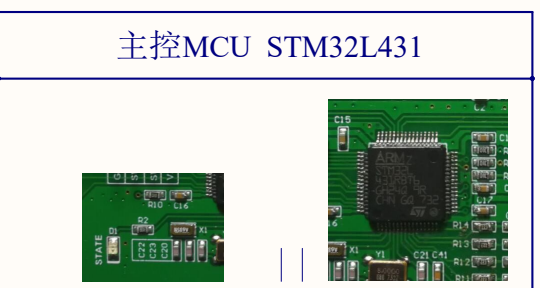

Ver	Date	Number	Revision
A1	2017/10/30	1	1
1.0	2017/10/30	1	1