

ARM<sup>®</sup> ARM926EJ-S Based

32-bit Microprocessor

# N9H20 Series Datasheet

*The information described in this document is the exclusive intellectual property of Nuvoton Technology Corporation and shall not be reproduced without permission from Nuvoton.*

*Nuvoton is providing this document only for reference purposes of ARM926EJ-S based system design. Nuvoton assumes no responsibility for errors or omissions.*

*All data and specifications are subject to change without notice.*

For additional information or questions, please contact: Nuvoton Technology Corporation.

[www.nuvoton.com](http://www.nuvoton.com)

**TABLE OF CONTENTS**

**LIST OF FIGURES ..... 5**

**LIST OF TABLES ..... 6**

**1 GENERAL DESCRIPTION..... 7**

    1.1 Applications ..... 7

**2 FEATURES ..... 8**

**3 PARTS INFORMATION LIST AND PIN CONFIGURATION..... 13**

    3.1 N9H20 Series Part Number Naming Guide..... 13

    3.2 N9H20 Series Part Selection Guide ..... 14

    3.3 Pin Configuration ..... 15

        3.3.1 N9H20K series Pin Diagram ..... 15

        3.3.2 N9H20R series Pin Diagram..... 16

    3.4 Pin Description ..... 17

        3.4.1 N9H20K series LQFP128 pin list ..... 17

        3.4.2 N9H20R series TQFP64 pin list ..... 25

**4 BLOCK DIAGRAM..... 30**

    4.1 N9H20 Series Block Diagram..... 30

**5 FUNCTIONAL DESCRIPTION..... 31**

    5.1 ARM® ARM926EJ-S CPU Core..... 31

        5.1.1 Overview ..... 31

    5.2 System Manager..... 32

        5.2.1 Overview ..... 32

    5.3 Clock Controller (CLK\_CTL)..... 32

        5.3.1 Overview ..... 32

    5.4 SDRAM Interface Controller (SDIC)..... 32

        5.4.1 Overview ..... 32

    5.5 2D Blitting Accelerator ..... 32

        5.5.1 Overview ..... 32

    5.6 JPEG Codec (JPEG) ..... 33

        5.6.1 Overview ..... 33

    5.7 LCD Display Interface Controller (VPOST) ..... 33

        5.7.1 Overview ..... 33

    5.8 Sound Processing Unit (SPU) ..... 33

        5.8.1 Overview ..... 33

    5.9 I<sup>2</sup>S Controller (I<sup>2</sup>S)..... 33

        5.9.1 Overview ..... 33

5.10	Storage Interface Controller .....	33
5.10.1	Overview .....	33
5.11	USB 2.0 Device Controller (USBD) .....	34
5.11.1	Overview .....	34
5.12	USB Host Controller (USBH) .....	34
5.12.1	Overview .....	34
5.13	Enhanced DMA Controller .....	34
5.13.1	Overview .....	34
5.14	Advanced Interrupt Controller (AIC) .....	34
5.14.1	Overview .....	34
5.15	General Purpose I/O (GPIO).....	35
5.15.1	Overview .....	35
5.16	Timer Controller (TMR).....	35
5.16.1	Overview .....	35
5.17	Watchdog Timer (WDT).....	35
5.17.1	Overview .....	35
5.18	Real Time Clock (RTC).....	35
5.18.1	Overview .....	35
5.19	I <sup>2</sup> C Synchronous Serial Interface Controller (I <sup>2</sup> C).....	36
5.19.1	Overview .....	36
5.20	Pulse Width Modulation (PWM) .....	36
5.20.1	Overview .....	36
5.21	UART Interface Controller (UART).....	36
5.21.1	Overview .....	36
5.22	SPI Interface Controller (SPI Master/Slaver) .....	36
5.22.1	Overview .....	36
5.23	Analog to Digital Converter (ADC).....	37
5.23.1	Overview .....	37
5.24	Keypad Interface (KPI) .....	37
5.24.1	Overview .....	37
<b>6</b>	<b>ELECTRICAL CHARACTERISTICS.....</b>	<b>38</b>
6.1	Absolute Maximum Ratings .....	38
6.2	DC Electrical Characteristics .....	39
6.2.1	N9H20 Series DC Electrical Characteristics .....	39
6.2.2	ADC Characteristics.....	40
6.2.3	Audio DAC Characteristics .....	40
6.3	AC Electrical Characteristics .....	42
6.3.1	External 12 MHz Crystal.....	42

6.3.2 Power-on Sequence & RESET .....43

6.3.3 I2C Interface.....44

6.3.4 I2S Interface .....45

6.3.5 LCD/ Display Interface.....46

6.3.6 SPI Interface.....48

6.3.7 NAND Interface.....49

6.3.8 SD Card Interface.....50

6.3.9 USB PHY Specifications.....51

6.3.10 Specification of Low Voltage Reset .....52

6.4 Thermal Characteristics of N9H20K Package ..... 53

**7 PACKAGE DIMENSIONS ..... 54**

7.1 128L LQFP (14x14x1.4mm footprint) ..... 54

**7.2 TQFP-64 (10X10X1.0mm body, 0.5mm pitch)..... 55**

7.3 PCB Reflow Profile Suggestion..... 58

7.3.1 Profile Setting Consideration .....58

7.3.2 Profile Suggestion for N9H20 series .....59

**8 REVISION HISTORY ..... 60**

**LIST OF FIGURES**

Figure 3-1 N9H20 Series Part Number Naming Guide..... 13  
Figure 3.3-1 N9H20K Series LQFP 128 Pin Diagram..... 15  
Figure 3.3-1 N9H20R Series LQFP 64 Pin Diagram ..... 16

**LIST OF TABLES**

No table of figures entries found.

nuvoTon Confidential

## 1 GENERAL DESCRIPTION

The N9H20 series is built on the ARM926EJ-S CPU@200MHz, synchronous DRAM, 2D BitBLT accelerator, LCD panel interface, USB 1.1 Host & USB2.0 HS Device core and integrated with JPEG codec, 32-channel SPU (Sound Processing Unit), ADC, DAC, for meeting various kinds of application needs for saving the BOM cost and makes the best choice for LCD application of cost/performance products.

Maximum resolution is XVGA (1,024x768)@TFT LCD panel. The 2D BitBLT accelerator accelerates the graphic computation to make the rendering smooth and off-load CPU to save power consumption.

The open source code environment provides the product development more flexibility. For reducing system complexity while cutting the BOM cost, the N9H20 series provides MCP (Multi-Chip Package) to ensure higher performance and to minimize the system design efforts. Total BOM cost could be cut by employing 2-layer PCB along with the elimination of external parts, EMI prevention components and saving board design space.

### 1.1 Applications

- HMI
- Home Appliance
- Advertisement

## 2 FEATURES

- CPU
  - ARM926EJ-S 32-bit RISC CPU with 8KB I-Cache & 8KB D-Cache
  - Frequency up to [200MHz@1.8V](#) core power operation voltage
  - JTAG interface supported for development and debugging
- Internal SRAM & ROM
  - 8KB internal SRAM and 16KB IBR internal booting ROM supported
  - IBR booting messages displayed by UART console for debugging supported
  - Different system booting modes supported:
    - ◆ Memory card
      - SD card or eMMC Flash device
      - SD-to-NAND flash bridge
    - ◆ Raw NAND Flash
    - ◆ SPI Flash
    - ◆ USB
- EDMA (Enhanced DMA)
  - Totally 5 DMA channels supported
    - ◆ 4 peripheral DMA channels for transfer between memory and on-chip peripherals, such as ADC, UART and SPI
    - ◆ One dedicated channel for memory-to-memory transfer
  - Byte, half-word and word data width types supported
  - Single and burst transfer modes supported
  - Block transfer supported in memory-to-memory transfer channel
  - Color format transformation supported in memory-to-memory transfer channel
    - ◆ Source color format could be RGB555, RGB565 and YCbCr422
    - ◆ Destination color format could be RGB555, RGB565 and YCbCr422
  - Auto reload supported for continuous data transfer
  - Interrupt generation supported in the half-of-transfer or end-of-transfer
- JPEG Codec
  - Baseline Sequential mode JPEG codec function compliant with ISO/IEC 10918-1 international JPEG standard supported.
  - Planar Format
    - ◆ Support to encode interleaved YCbCr 4:2:2/4:2:0 and gray-level (Y only) format image
    - ◆ Support to decode interleaved YCbCr 4:4:4/4:2:2/4:2:0/4:1:1 and gray-level (Y only) format image
    - ◆ Support to decode YCbCr 4:2:2 transpose format
    - ◆ Support arbitrary width and height image encode and decode
    - ◆ Support three programmable quantization-tables
    - ◆ Support standard default Huffman-table and programmable Huffman-table for decode
    - ◆ Support arbitrarily 1X~8X image up-scaling function for encode mode
    - ◆ Support down-scaling function for encode and decode modes
    - ◆ Support specified window decode mode
    - ◆ Support quantization-table adjustment for bit-rate and quality control in encode mode
    - ◆ Support rotate function in encode mode
  - Packet Format
    - ◆ Support to encode interleaved YUYV format input image, output bitstream 4:2:2 and 4:2:0 format
    - ◆ Support to decode interleaved YCbCr 4:4:4/4:2:2/4:2:0 format image
    - ◆ Support decoded output image RGB555, RGB565 and RGB888 formats.

- ◆ The encoded JPEG bit-stream format is fully compatible with JFIF and EXIF standards
- ◆ Support arbitrary width and height image encode and decode
- ◆ Support three programmable quantization-tables
- ◆ Support standard default Huffman-table and programmable Huffman-table for decode
- ◆ Support arbitrarily 1X~8X image up-scaling function for encode mode
- ◆ Support down-scaling function 1X~ 16X for Y422 and Y420, 1X~ 8X for Y444 for decode mode
- ◆ Support specified window decode mode
- ◆ Support quantization-table adjustment for bit-rate and quality control in encode mode
- 2D Accelerator
  - BitBLT operation
    - ◆ 2x2 transform matrix with effects:
      - Scale
      - Translate
      - Rotate
      - Shear
    - ◆ Alpha blending and color transformation supported
    - ◆ Source format for operations: supported color format of source bitmap
  - Fill
    - ◆ Rectangle Fill with single color – ARGB8888
    - ◆ Fill with blending effect supported
  - Supported color formats
    - ◆ Source
      - 16 bits/pixel – RGB565
      - 32 bits/pixel – ARGB8888
      - 1 bit/pixel, 2 bits/pixel, 4 bits/pixel, 8 bits/pixel with RGB color palette
    - ◆ Destination
      - 16 bits/pixel – RGB565
      - 32 bits/pixel – ARGB8888
- VPOST
  - 8/16/18/24-bit SYNC type and 8/9/16/18/24-bit MPU type TFT LCD supported
  - Color format supported:
    - ◆ YCbCr422, RGB565, RGB555, and RGB888 color formats supported for data in
    - ◆ YCbCr422, RGB565, RGB555, and RGB888 color formats supported for data out
  - XGA (1024x768), SVGA (800x600), WVGA (800x480), D1 (720x480), VGA (640x480), WQVGA (480x272), QVGA (320x240) and HVGA (640x240) resolution supported
    - ◆ The maximum resolution is up to 1024X768 for TFT LCD panel for still image displaying
    - ◆ The maximum resolution is up to 480x272 for TFT LCD panel for MJPEG video displaying up to 25fps.
  - Display scaler – to fit different size of LCD panels
    - ◆ Horizontal: At most 4.0x scale
    - ◆ Vertical: At most 3.0x scale
  - For SYNC type LCD:
    - ◆ For 8-bit bus
      - CCIR601 YCbCr422 packet mode (NTSC/PAL) supported
      - CCIR601 RGB Dummy mode (NTSC/PAL) supported
      - CCIR656 interface supported
      - RGB Through mode supported
    - ◆ For 16/18/24-bit bus
      - Parallel pixel data output mode (1-pixel/1-clock)

- NTSC/PAL interlace & non-interlace output supported
  - Color format transform supported:
    - ◆ Color format transform between YCbCr422 and RGB565
    - ◆ Color format transform from YCbCr422 to RGB888
  - Support OSD function to overlap system information like battery life, brightness tuning, volume tuning or muting, etc.
- Frame Switch Controller
  - Frame relation controlled between VPOST and Capture supported
  - 2 modes supported to switch Frame Buffer Base
    - ◆ Frame Ratio Mode (16 selectable ratio)
    - ◆ Frame sync mode
  - Double/triple buffers supported
- SPU (Sound Processing Unit)
  - 32 stereo channels supported
  - PCM8/PCM16/4-bit MDPCM/TONE source format supported
  - 7-bit volume control supported for each of 32 channels
  - 5-bit pan control supported for each L/R of 32 channels
  - 10-band equalizer supported
  - Special code supported for loop playing and event detection
- Audio DAC
  - 16-bit stereo DAC supported with headphone driver output
  - H/W volume control supported
- I2S Controller
  - I2S interface supported to connect external audio codec
  - 16/18/20/24-bit data format supported
- Storage Interface Controller
  - Interface to NAND Flash:
    - ◆ 8-bit data bus width supported
    - ◆ SLC and MLC type NAND Flash supported
    - ◆ 512B, 2KB, 4KB, and 8KB page size NAND Flash supported
    - ◆ ECC4, ECC8, ECC12 and ECC15 algorithm supported for ECC generation, error detection and error correction
    - ◆ PBA-NAND flash supported
  - Interface to SD/MMC/SDIO/SDHC/micro-SD cards/ eMMC Flash device supported
    - ◆ SD-to-NAND flash bridge supported
  - DMA function supported to accelerate the data transfer between system memory and NAND Flash or SD/MMC/SDIO/SDHC/micro-SD/eMMC Flash device
- USB Device Controller
  - USB2.0 HS (High-Speed) x 1 port
  - 6 configurable endpoints supported
  - Control, Bulk, Interrupt and Isochronous transfers supported
  - Suspend and remote wakeup supported
- USB Host Controller
  - USB1.1 Host one H/W Engine, two pin locations.
  - Fully compliant with USB Revision 1.1 specification
  - Open Host Controller Interface (OHCI) Revision 1.0 compatible
  - Full-speed (12Mbps) and low-speed (1.5Mbps) USB devices supported

- Control, Bulk, Interrupt and Isochronous transfers supported
- Timer & Watch-Dog Timer
  - Two 32-bit with 8-bit pre-scalar timers supported
  - One programmable 24-bit Watch-Dog Timer supported
- PWM
  - 4 PWM channel outputs supported
  - 16-bit counter supported for each PWM channel
  - Two 8-bit pre-scalars supported and each pre-scalar shared by two PWM channels
  - Two clock-dividers supported and each divider shared by two PWM channels
  - Two Dead-Zone generators supported and each generator shared by two PWM channels
  - Auto reloaded mode and one-shot pulse mode supported
  - Capture function supported
- UART
  - A high speed UART supported:
    - ◆ Baud rate is up to 1M bps
    - ◆ 4 signals TX, RX, CTS and RTS supported
  - A normal UART supported:
    - ◆ Baud rate is up to 115.2K bps
    - ◆ 2 signals TX and RX supported only
- SPI
  - Two SPI controller is supported
    - ◆ Both master and slave mode are supported in SPI interface
    - ◆ Two chip selection signals for two SPI devices
- I2C
  - One I2C channel supported
  - Compatible with Philips's I<sup>2</sup>C standard and only master mode supported
  - Multi-master operation supported
- Advanced Interrupt Controller
  - Total 32 interrupt source supported
  - Configurable interrupt type:
    - ◆ Low-active level triggered interrupt
    - ◆ High-active level triggered interrupt
    - ◆ Low-active edge (falling edge) triggered interrupt
    - ◆ High-active edge (rising edge) triggered interrupt
  - Individual interrupt mask bit for each interrupt source
  - 8 different priority levels supported
  - Daisy-chain priority mechanism supported for interrupts with same priority level
  - Low priority interrupt automatic masking supported for interrupt nesting
- RTC
  - Independent power plane supported
  - 32.768 KHz crystal oscillation circuit supported
  - Time counter (second, minute, hour) and Calendar counter (day, month, year) supported
  - Alarm supported (second, minute, hour, day, month and year)
  - 12/24-hour mode and Leap year supported
  - Alarm to wake chip up from Standby mode or from Power-down mode supported

- Wake chip up from Power-down mode by input pin supported
  - Power-off chip by register setting supported
  - Power-on timeout is supported for low battery protection
- GPIO
  - 70 programmable general purpose I/Os supported and separated into 5 groups
  - Individual configuration supported for each I/O signal
  - Configurable interrupt control functions supported
  - Configurable de-bounce circuit supported for interrupt function
- ADC
  - Multi-channel, 10-bit ADC supported
    - ◆ 2 channels dedicated for 4-wire resistive touch sensor inputs
    - ◆ 2 channels dedicated for Audio ADC with Microphone pre-Amp & AGC
    - ◆ 3 channels reserved for various purposes, like LVD (Low Voltage Detection), keypad input, and light sensor
    - ◆ Input voltage range from 0V ~ 3.3V supported
  - Maximum 25MHz input clock supported
  - Maximum 400K/s conversion rate supported
  - LVR (Low Voltage Reset) supported
- Power Management
  - Advanced power management including Power Down, Deep Standby, CPU Standby, and Normal Operating modes
    - ◆ Normal Operating Mode
      - Core power is 1.8V and chip is in normal operation
    - ◆ CPU Standby Mode
      - Core power is 1.8V and only ARM CPU clock is turned OFF
    - ◆ Deep Standby Mode
      - Core power is 1.8V and all IP clocks are turned OFF
    - ◆ Power Down Mode
      - Only the RTC power is ON. Other 3.3V and 1.8V power are OFF
- Operating Voltage
  - I/O: 3.3V
  - Core: 1.8V
- Package
  - LQFP-128 MCP
  - TQFP-64 MCP

### 3 PARTS INFORMATION LIST AND PIN CONFIGURATION

#### 3.1 N9H20 Series Part Number Naming Guide

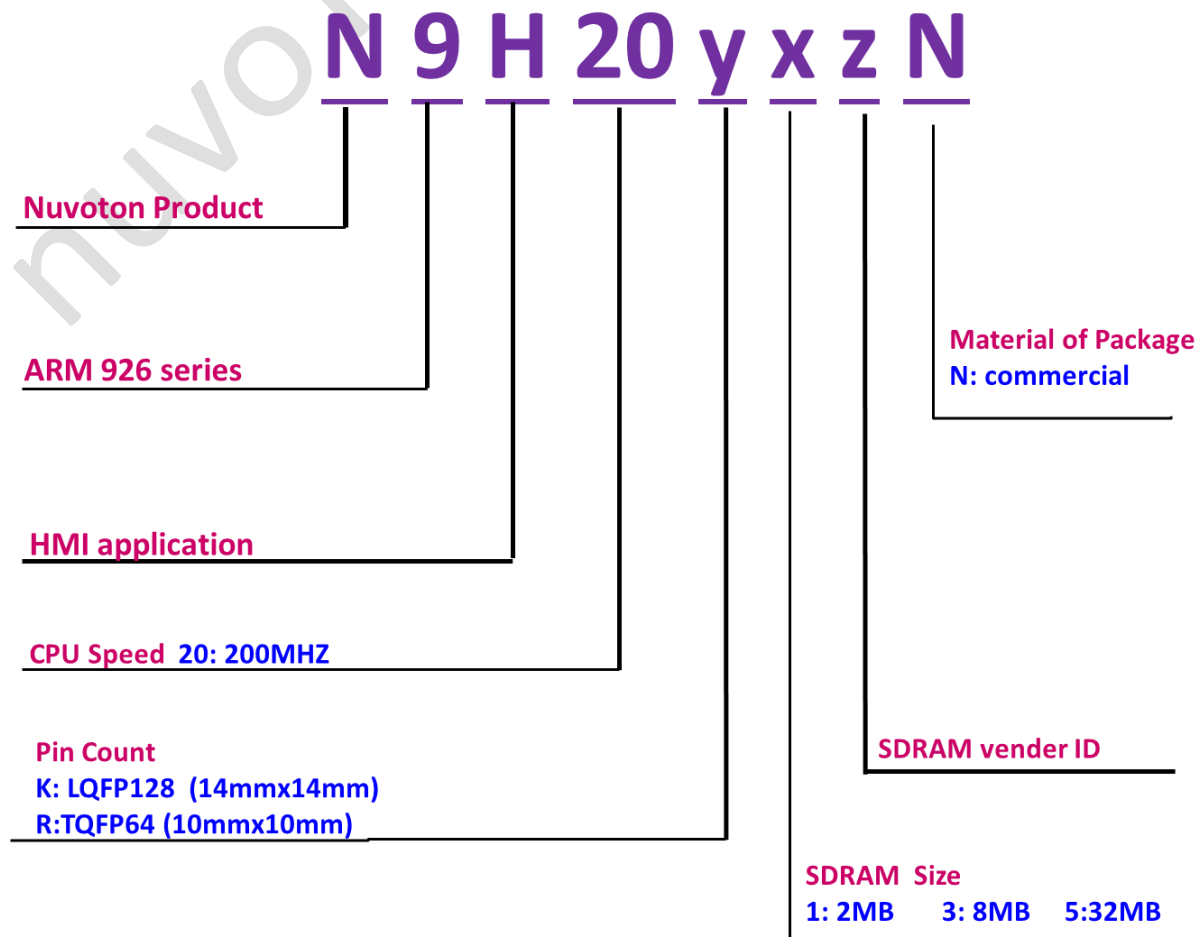

Figure 3-1 N9H20 Series Part Number Naming Guide

### 3.2 N9H20 Series Part Selection Guide

N9H20 series																																	
Part No.	Core				Memory				USB	H/W Accelerator	LCD	Analog			Peripheral						Power			PKG									
	Max Speed (MHz)	ARM CPU	I Cache (KB)	D Cache (KB)	SRAM (KB)	Stacked DRAM	SPI Flash I/F	Raw NAND I/F, ECC bits	eMMC/SD / SDIO	1.1 Host (12 Mbps)	Device (FS / HS)	2D BitBLT GFX	JPEG Codec	Video Codec	RGB Color (bits)	Max. Resolution <sup>1</sup>	10/12-bit SAR ADC	4/5-wire TP ADC	Audio Stereo DAC	JTAG	GPIO (Max)	UART	I2C	SPI booting	SPI	RTC	PWM	I2S	Core Voltage (V)	DRAM Voltage (V)	IO Voltage (V)	Package	Status <sup>2</sup>
N9H20R11N	200	926	8	8	8	2MB	√	-	1	1	HS	√	√	JPEG	16	QVGA	-	-	-	√	44	2	1	√	1	-	4	-	1.8	3.3	3.3	TQFP-64	MP
N9H20K51N	200	926	8	8	8	32MB	√	15	3	1	HS	√	√	JPEG	24	XGA <sup>3</sup>	10	4W	√	√	70	2	1	√	2	√	4	√	1.8	1.8	3.3	LQFP-128	MP
N9H20K31N	200	926	8	8	8	8MB	√	15	3	1	HS	√	√	JPEG	24	XGA <sup>3</sup>	10	4W	√	√	70	2	1	√	2	√	4	√	1.8	1.8	3.3	LQFP-128	MP
N9H20K11N	200	926	8	8	8	2MB	√	15	3	1	HS	√	√	JPEG	24	QVGA	10	4W	√	√	70	2	1	√	2	√	4	√	1.8	3.3	3.3	LQFP-128	MP

<sup>1</sup> Resolution: QVGA (320x240), VGA (640x480), SVGA (800x600), XGA (1024 x 768).  
<sup>2</sup> Status: MP - Mass Production, ES - Engineering Sample, UD - Under Development.  
<sup>3</sup> XGA is for still image only.

### 3.3 Pin Configuration

#### 3.3.1 N9H20K series Pin Diagram

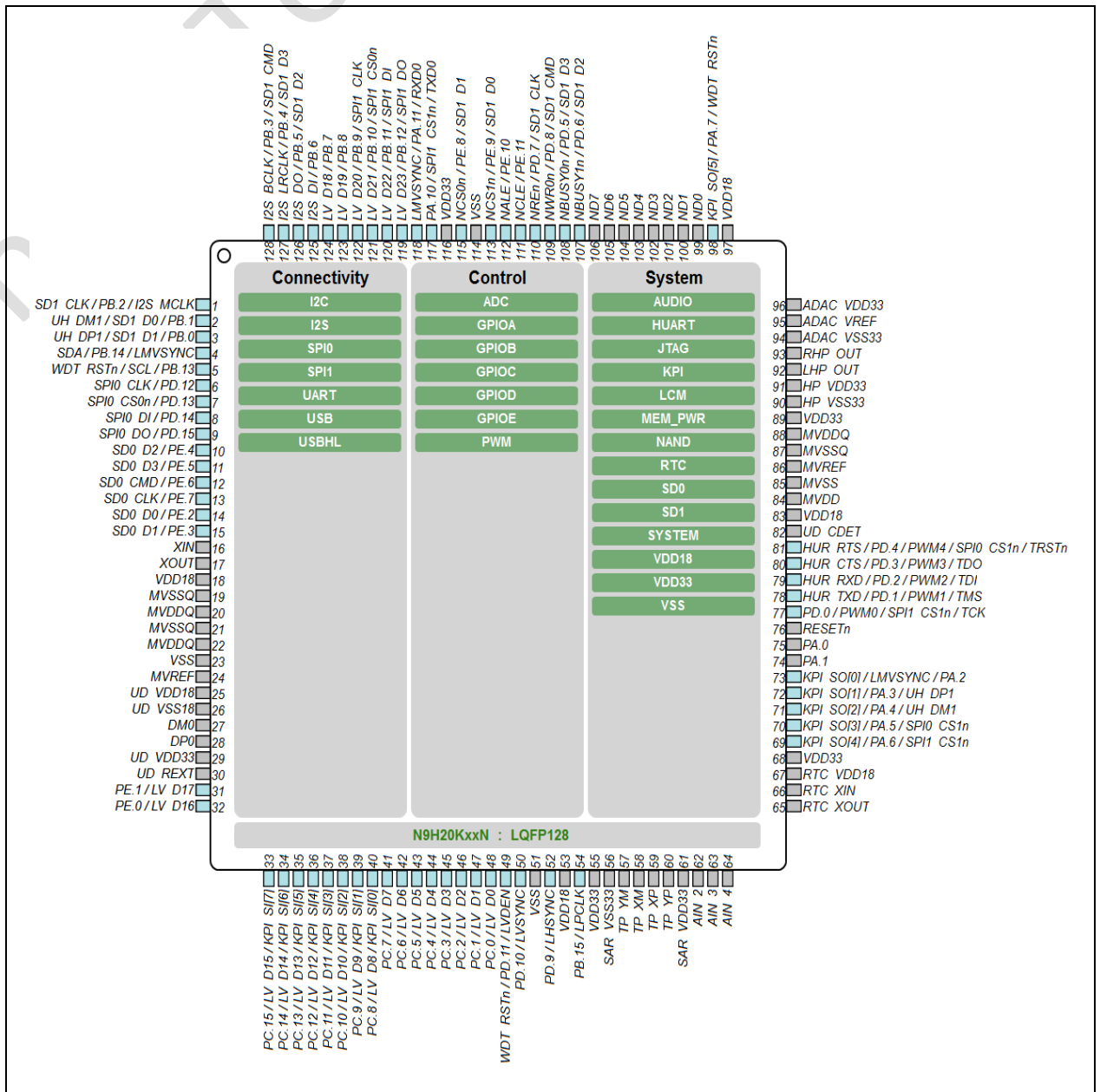

Figure 3.3-1 N9H20K Series LQFP 128 Pin Diagram

3.3.2 N9H20R11N Pin Diagram

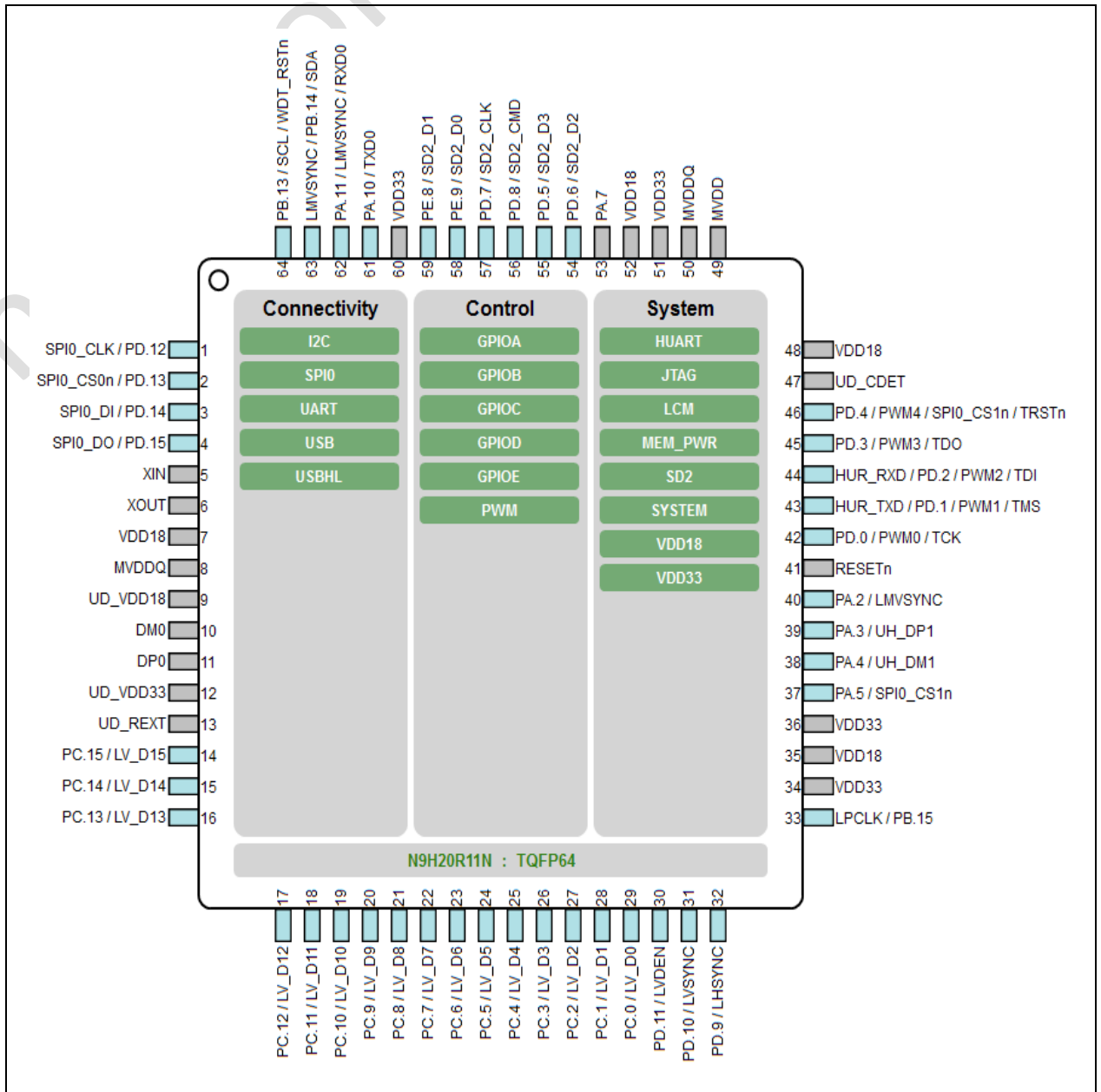

Figure 3.3-2 N9H20R11N TQFP 64 Pin Diagram

### 3.4 Pin Description

#### 3.4.1 N9H20K series LQFP128 pin list

Pin No	Name	Type	Group	Description
1	GPB[2]	IOU	GPIOB	GPIO Port B Bit 2
	I2S_MCLK	OU	I <sup>2</sup> S	Clock to I2S Codec, Output
	SD1_CLK	OU	SD1	SD Port 1 Clock, Output
2	GPB[1]	IOU	GPIOB	GPIO Port B Bit 1
	SD1_DAT[0]	IOU	SD1	SD Port 1 Data Bit 0
	UHL_DM1	IOU	USB	USB Host 1.0 Lite Port 1, D-E154
3	GPB[0]	IOU	JTAG	GPIO Port B Bit 0
	SD1_DAT[1]	IOU	SD1	SD Port 1 Data Bit 1
	UHL_DP1	IOU	USB	USB Host 1.0 Lite Port 1, D+
4	ISDA	IOU	I2C	I2C Interface Data
	GPB[14]	IOU	GPIOB	GPIO Port B Bit 14
	LFMARK	IU	LCD	MPU LCD Interface Frame Mark, Input
	LMVSYNC	OU	LCD	MPU LCD Interface Mode VSYNC, Output
5	ISCK	OU	I2C	I2C Interface Clock, Output
	GPB[13]	IOU	GPIOB	GPIO Port B Bit 13
6	SPI0_CLK	IOU	SPI0	SPI Port 0 Clock;Output in Master Mode;Input in Slave Mode
	GPD[12]	IOU	GPIOD	GPIO Port D Bit 12
7	SPI0_CS0_	IOU	SPI0	SPI Port 0 Device Select 0, Low Active;Output in Master Mode;Input in Slave Mode
	GPD[13]	IOU	GPIOD	GPIO Port D Bit 13
8	SPI0_DI	IU	SPI0	SPI Port 0 Data Input
	GPD[14]	IOU	GPIOD	GPIO Port D Bit 14
9	SPI0_DO	OU	SPI0	SPI Port 0 Data Output
	GPD[15]	IOU	GPIOD	GPIO Port D Bit 15
10	SD0_DAT[2]	IOU	SD0	SD Port 0 Data Bit 2
	GPE[4]	IOU	GPIOE	GPIO Port E Bit 4
11	SD0_DAT[3]	IOU	SD0	SD Port 0 Data Bit 3
	GPE[5]	IOU	GPIOE	GPIO Port E Bit 5
12	SD0_CMD	IOU	SD0	SD Port 0 Command/Response
	GPE[6]	IOU	GPIOE	GPIO Port E Bit 6
13	SD0_CLK	OU	SD0	SD Port 0 Clock, Output
	GPE[7]	IOU	GPIOE	GPIO Port E Bit 7
14	SD0_DAT[0]	IOU	SD0	SD Port 0 Data Bit 0

	GPE[2]	IOU	GPIOE	GPIO Port E Bit 2
15	SD0_DAT[1]	IOU	SD0	SD Port 0 Data Bit 1
	GPE[3]	IOU	GPIOE	GPIO Port E Bit 3
16	XIN	I	XTAL	12MHz Crystal Input
17	XOUT	O	XTAL	12MHz Crystal Output
18	VDD18	P	Core	Core Logic Power (1.8V)
19	VSSQ	G	MVDD	SDRAM I/F Ground (0V)
20	VDDQ	P	MVDD	SDRAM I/F Power
21	VSSQ	G	MVDD	SDRAM Ground (0V)
22	MVDD	P	MVDD	SDRAM Power
23	VSS	G	GND	Ground (0V)
24	NC	--	NC	when N9H20K11N is installation
	MVREF	P	MVDD	1/2 MVDD (0.9V) for DDR_VREF
25	PLL_UD_VDD18	P	PLL & USB	PLL & USB2.0 Device Core Power (1.8V)
26	UD_VSS	G	USB	USB2.0 Device Ground (0V)
27	UD_DM	I/O	USB	USB 2.0 Device D-
28	UD_DP	I/O	USB	USB 2.0 Device D+
29	UD_VDD33	P	USB	USB 2.0 Device PHY 3.3V
30	UD_REXT	O	USB	External Resistor 12.1K resistor connected to ground
31	LVDATA[17]	IOU	LCD	SYNC/MPU LCD Interface Data Bit 17
	GPE[1]	IOU	GPIOE	GPIO Port E Bit 1
32	LVDATA[16]	IOU	LCD	SYNC/MPU LCD Interface Data Bit 16
	GPE[0]	IOU	GPIOE	GPIO Port E Bit 0
33	LVDATA[15]	IOU	LCD	SYNC/MPU LCD Interface Data Bit 15
	GPC[15]	IOU	GPIOC	GPIO Port C Bit 15
	KPI_SI[7]	IU	KPI	KPI Scan In Bit 7
34	LVDATA[14]	IOU	LCD	SYNC/MPU LCD Interface Data Bit 14
	GPC[14]	IOU	GPIOC	GPIO Port C Bit 14
	KPI_SI[6]	IU	KPI	KPI Scan In Bit 6
35	LVDATA[13]	IOU	LCD	SYNC/MPU LCD Interface Data Bit 13
	GPC[13]	IOU	GPIOC	GPIO Port C Bit 13
	KPI_SI[5]	IU	KPI	KPI Scan In Bit 5
36	LVDATA[12]	IOU	LCD	SYNC/MPU LCD Interface Data Bit 12
	GPC[12]	IOU	GPIOC	GPIO Port C Bit 12
	KPI_SI[4]	IU	KPI	KPI Scan In Bit 4
37	LVDATA[11]	IOU	LCD	SYNC/MPU LCD Interface Data Bit 11

	GPC[11]	IOU	GPIOC	GPIO Port C Bit 11
	KPI_SI[3]	IU	KPI	KPI Scan In Bit 3
38	LVDATA[10]	IOU	LCD	SYNC/MPU LCD Interface Data Bit 10
	GPC[10]	IOU	GPIOC	GPIO Port C Bit 10
	KPI_SI[2]	IU	KPI	KPI Scan In Bit 2
39	LVDATA[9]	IOU	LCD	SYNC/MPU LCD Interface Data Bit 9
	GPC[9]	IOU	GPIOC	GPIO Port C Bit 9
	KPI_SI[1]	IU	KPI	KPI Scan In Bit 1
40	LVDATA[8]	IOU	LCD	SYNC/MPU LCD Interface Data Bit 8
	GPC[8]	IOU	GPIOC	GPIO Port C Bit 8
	KPI_SI[0]	IU	KPI	KPI Scan In Bit 0
41	LVDATA[7]	IOU	LCD	SYNC/MPU LCD Interface Data Bit 7
	GPC[7]	IOU	GPIOC	GPIO Port C Bit 7
42	LVDATA[6]	IOU	LCD	SYNC/MPU LCD Interface Data Bit 6
	GPC[6]	IOU	GPIOC	GPIO Port C Bit 6
	CFG[10]	IU	SYSTEM	Chip Power-On Configuration Bit [10], Input
43	LVDATA[5]	IOU	LCD	SYNC/MPU LCD Interface Data Bit 5
	GPC[5]	IOU	GPIOC	GPIO Port C Bit 5
	CFG[9]	IU	SYSTEM	Chip Power-On Configuration Bit [9], Input
44	LVDATA[4]	IOU	LCD	GPIO Port C Bit 4
	GPC[4]	IOU	GPIOC	GPIO Port C Bit 4
	CFG[8]	IU	SYSTEM	Chip Power-On Configuration Bit [8], Input
45	LVDATA[3]	IOU	LCD	SYNC/MPU LCD Interface Data Bit 3
	GPC[3]	IOU	GPIOC	GPIO Port C Bit 3
46	LVDATA[2]	IOU	LCD	SYNC/MPU LCD Interface Data Bit 2
	GPC[2]	IOU	GPIOC	GPIO Port C Bit 2
47	LVDATA[1]	IOU	LCD	SYNC/MPU LCD Interface Data Bit 1
	GPC[1]	IOU	GPIOC	GPIO Port C Bit 1
48	LVDATA[0]	IOU	LCD	SYNC/MPU LCD Interface Data Bit 0
	GPC[0]	IOU	GPIOC	GPIO Port C Bit 0
49	LVDE	OU	LCD	SYNC LCD Interface Data Enable, Output, High Active
	LRS	OU	LCD	MPU LCD Interface Register Select
	GPD[11]	IOU	GPIOD	GPIO Port D Bit 11 <b>Note. By design limitation, GPD[11] function will be disable when SPI1 engine is used.</b>
50	LVSYNC	OU	LCD	SYNC LCD Interface VSYNC, Output, High Active

	LRD	OU	LCD	MPU I80 mode LCD Interface Read, active low
	LEN	OU	LCD	MPU M68 mode LCD Interface Read Write Enable/Disable , High Enable
	GPD[10]	IOU	GPIOD	LCD Interface Data Enable, High Active.
51	VSS	G	GND	Ground (0V)
52	LHSYNC	OU	LCD	SYNC LCD Interface HSYNC, Output, High Active
	LWR	OU	LCD	MPU I80 mode LCD Interfacer Write, active low
	LR/W	OU	LCD	MPU M68 mode LCD interface R/W, High is read command and Low is write instruction
	GPD[9]	IOU	GPIOD	GPIO Port D Bit 9
53	VDD18	P	Core	Core Logic Power (1.8V)
54	LPCLK	OU	LCD	SYNC LCD Interface Pixel Clock, Output
	LCS	OU	LCD	MPU LCD Interface Chip Enable, active low
	GPB[15]	IOU	GPIOB	GPIO Port B Bit 15
55	VDD33	P	I/O	I/O Power (3.3V)
56	ADC_VSS33	G	ADC	ADC Ground (0V)
57	ADC_TP_YM	I	ADC	Touch Panel YM
58	ADC_TP_XM	I	ADC	Touch Panel XM
59	ADC_TP_XP	I	ADC	Touch Panel XP
60	ADC_TP_YP	I	ADC	Touch Panel YP
61	ADC_VDD33	P	ADC	ADC Power (3.3V)
62	ADC_AIN[2]	I	ADC	ADC Analog Input Channel 2
63	ADC_AIN[3]	I	ADC	ADC Analog Input Channel 3
64	ADC_AIN[4]	I	ADC	ADC Analog Input Channel 4
65	RTC_XOUT	O	RTC	32768Hz Crystal Output
66	RTC_XIN	I	RTC	32768Hz Crystal Input
67	RTC_VDD1.8V	P	RTC	RTC Power (1.8V)
68	VDD33	P	I/O	I/O Power (3.3V)
69	GPA[6]	IOU	GPIOA	GPIO Port A Bit 6
	SPI1_CS1_	OU	SPI1	SPI Port 1 Device Select 1, Output, Low Active
	KPI_SO[4]	OU	KPI	KPI Scan Out Bit 4
70	GPA[5]	IOU	GPIOA	GPIO Port A Bit 5
	SPI0_CS1_	OU	SPI0	SPI Port 0 Device Select 1, Output, Low Active
	KPI_SO[3]	OU	KPI	KPI Scan Out Bit 3
71	GPA[4]	IOU	GPIOA	GPIO Port A Bit 4
	UHL_DM1	IOU	USB	USB Host 1.0 Lite Port 1, D-

	KPI_SO[2]	OU	KPI	KPI Scan Out Bit 2
72	GPA[3]	IOU	GPIOA	GPIO Port A Bit 3
	UHL_DP1	IOU	USB	USB Host 1.0 Lite Port 1, D+
	KPI_SO[1]	OU	KPI	KPI Scan Out Bit 1
73	GPA[2]	IOU	GPIOA	GPIO Port A Bit 2
	LMVSYNC	OU	LCD	MPU LCD Interface VSYNC, Output
	LFMARK	IU	LCD	MPU LCD Interface Frame Mark, Input
	KPI_SO[0]	OU	KPI	KPI Scan Out Bit 0
74	GPA[1]	IOU	GPIOA	GPIO Port A Bit 1
	SD_CD_	IU	SD	SD Card Detect, Input, Low Active
75	GPA[0]	IOU	GPIOA	GPIO Port A Bit 0
76	RST_	IU	SYSTEM	System Reset, Input, Low Active
	WDT_RST_	OU	SYSTEM	Watch-Dog Reset, Output, Low Active
77	TCK	ID	JTAG	JTAG Interface Test Clock, Input
	GPD[0]	IOD	GPIOD	GPIO Port D Bit 0
	SPI1_CS1_	OD	SPI1	SPI Port 1 Device Select 1, Output, Low Active
	PWM0	OD	PWM	PWM Channel 0
78	TMS	IU	JTAG	JTAG Interface Test Mode Select, Input
	GPD[1]	IOU	GPIOD	GPIO Port D Bit 1
	HUR_TXD	OU	UART	High-Speed UART TX Data, Output
	PWM1	OU	PWM	PWM Channel 1
79	TDI	IU	JTAG	JTAG Interface Test Data In, Input
	GPD[2]	IOU	GPIOD	GPIO Port D Bit 2
	HUR_RXD	IU	UART	High-Speed UART RX Data, Input
	PWM2	OU	PWM	PWM Channel 2
80	TDO	OU	JTAG	JTAG Interface Test Data Out, Output
	GPD[3]	IOU	GPIOD	GPIO Port D Bit 3
	HUR_CTS	IU	UART	High-Speed UART Clear-To-Send, Input, Low Active
	PWM3	OU	PWM	PWM Channel 3
81	TRST_	IU	JTAG	JTAG Interface Test Reset, Input, Low Active
	GPD[4]	IOU	GPIOD	GPIO Port D Bit 4
	HUR_RTS	OU	UART	High-Speed UART Reset-To-Send, Output, Low Active
	SPI0_CS1_	OU	SPI0	SPI Port 0 Device Select 1, Output, Low Active
82	UD_CDET	I	USB	USB Device Connect Detect, Input, High Active
83	VDD18	P	Core	Core Logic Power (1.8V)
84	MVDD	P	MVDD	SDRAM I/O Power

85	MVSS	G	MVDD	SDRAM I/F Ground (0V)
86	MVREF	P	MVDD	1/2 MVDD (0.9V) for DDR_VREF
	NC	--	NC	when N9H20K11N is installation
87	VSSQ	G	MVDD	SDRAM Ground (0V)
88	VDDQ	P	MVDD	SDRAM Power
89	VDD33	P	I/O	I/O Power (3.3V)
90	ADAC_HPVS33	G	AUDIO	Audio DAC Headphone Driver Ground (0V)
91	ADAC_HPVD33	P	AUDIO	Audio DAC Headphone Driver Power (3.3V)
92	ADAC_HPOUT_L	O	AUDIO	Audio Headphone Left Channel Output
93	ADAC_HPOUT_R	O	AUDIO	Audio Headphone Right Channel Output
94	ADAC_AVSS33	G	AUDIO	Audio DAC Ground (0V)
95	ADAC_VREF	O	AUDIO	Audio DAC Reference Voltage Output, please connect 1uF capacitor to DAC ground
96	ADAC_AVDD33	P	AUDIO	Audio DAC Power (3.3V)
97	VDD18	P	Core	Core Logic Power (1.8V)
98	GPA[7]	IOU	GPIOA	GPIO Port A Bit 7
	KPI_SO[5]	OU	KPI	KPI Scan Out Bit 5
99	ND[0]	IOU	NAND	NAND Interface Data Bit [0]
	CFG[0]	IU	SYSTEM	Chip Power-On Configuration Bit [0], Input
100	ND[1]	IOU	NAND	NAND Interface Data Bit [1]
	CFG[1]	IU	SYSTEM	Chip Power-On Configuration Bit [1], Input
101	ND[2]	IOU	NAND	NAND Interface Data Bit [2]
	CFG[2]	IU	SYSTEM	Chip Power-On Configuration Bit [2], Input
102	ND[3]	IOU	NAND	NAND Interface Data Bit [3]
	CFG[3]	IU	SYSTEM	Chip Power-On Configuration Bit [3], Input
103	ND[4]	IOU	NAND	NAND Interface Data Bit [4]
	CFG[4]	IU	SYSTEM	Chip Power-On Configuration Bit [4], Input
104	ND[5]	IOU	NAND	NAND Interface Data Bit [5]
	CFG[5]	IU	SYSTEM	Chip Power-On Configuration Bit [5], Input
105	ND[6]	IOU	NAND	NAND Interface Data Bit [6]
	CFG[6]	IU	SYSTEM	Chip Power-On Configuration Bit [6], Input
106	ND[7]	IOU	NAND	NAND Interface Data Bit [7]
	CFG[7]	IU	SYSTEM	Chip Power-On Configuration Bit [7], Input
107	NBUSY1_	IU	NAND	NAND Interface Busy 1, Input, Low Active
	GPD[6]	IOU	GPIOD	GPIO Port D Bit 6
	SD2_DAT[2]	IOU	SD2	SD Port 2 Data Bit 2

108	NBUSY0_	IU	NAND	NAND Interface Busy 0, Input, Low Active
	GPD[5]	IOU	GPIOD	GPIO Port D Bit 5
	SD2_DAT[3]	IOU	SD2	SD Port 2 Data Bit 3
109	NWR_	OU	NAND	NAND Interface Write Enable, Output, Low Active
	GPD[8]	IOU	GPIOD	GPIO Port D Bit 8
	SD2_CMD	IOU	SD2	SD Port 2 Command/Response
110	NRE_	OU	NAND	NAND Interface Read Enable, Output, Low Active
	GPD[7]	IOU	GPIOD	GPIO Port D Bit 7
	SD2_CLK	OU	SD2	SD Port 2 Clock, Output
111	NCLE	OU	NAND	NAND Interface Command-Latch-Enable, Output, High Active
	GPE[11]	IOU	GPIOE	GPIO Port E Bit 11
112	NALE	OU	NAND	NAND Interface Address-Latch-Enable, Output, High Active
	GPE[10]	IOU	GPIOE	GPIO Port E Bit 10
113	NCS1_	OU	NAND	NAND Interface Chip Select 1, Output, Low Active
	GPE[9]	IOU	GPIOE	GPIO Port E Bit 9
	SD2_DAT[0]	IOU	SD2	SD Port 2 Data Bit 0
114	VSS	G	GND	Ground (0V)
115	NCS0_	IU	NAND	NAND Interface Chip Select 0, Output, Low Active
	GPE[8]	IOU	GPIOE	GPIO Port E Bit 8
	SD2_DAT[1]	IOU	SD2	SD Port 2 Data Bit 1
116	VDD33	P	I/O	I/O Power (3.3V)
117	URTXD	OU	UART	UART TX Data, Output
	GPA[10]	IOU	GPIOA	GPIO Port A Bit 10
	SPI1_CS1_	OU	SPI1	SPI Port 1 Device Select 1, Output, Low Active
118	URRXD	IU	UART	UART RX Data, Input
	GPA[11]	IOU	GPIOA	GPIO Port A Bit 11
	LMVSYNC	OU	LCD	MPU LCD Interface VSYNC, Output
	LFMARK	IU	LCD	MPU LCD Interface Frame Mark, Input
119	GPB[12]	IOU	GPIOB	GPIO Port B Bit 12
	SPI1_DO	OU	SPI1	SPI Port 1 Data Output
	LVDATA[23]	IOU	LCD	SYNC/MPU LCD Interface Data Bit 23
120	GPB[11]	IOU	GPIOB	GPIO Port B Bit 11
	SPI1_DI	IU	SPI1	SPI Port 1 Data Input
	LVDATA[22]	IOU	LCD	SYNC/MPU LCD Interface Data Bit 22
121	GPB[10]	IOU	GPIOB	GPIO Port B Bit 10
	SPI1_CS0_	IOU	SPI1	SPI Port 1 Device Select 0, Low Active;Output in Master

				Mode;Input in Slave Mode
	LVDATA[21]	IOU	LCD	SYNC/MPU LCD Interface Data Bit 21
122	GPB[9]	IOU	GPIOB	GPIO Port B Bit 9
	SPI1_CLK	IOU	SPI1	SPI Port 1 Clock;Output in Master Mode;Input in Slave Mode
	LVDATA[20]	IOU	LCD	SYNC/MPU LCD Interface Data Bit 20
123	GPB[8]	IOU	GPIOB	GPIO Port B Bit 8
	LVDATA[19]	IOU	LCD	SYNC/MPU LCD Interface Data Bit 19
124	GPB[7]	IOU	GPIOB	GPIO Port B Bit 7
	LVDATA[18]	IOU	LCD	SYNC/MPU LCD Interface Data Bit 18
125	GPB[6]	IOU	GPIOB	GPIO Port B Bit 6
	I2S_DIN	IU	I <sup>2</sup> S	I2S Interface Data Input
126	GPB[5]	IOU	GPIOB	GPIO Port B Bit 5
	I2S_DOUT	OU	I2S	I2S Interface Data Output
	SD1_DAT[2]	IOU	SD1	SD Port 1 Data Bit 2
127	GPB[4]	IOU	GPIOB	GPIO Port B Bit 4
	I2S_WS	OU	I <sup>2</sup> S	I2S Interface Word Select, Output
	SD1_DAT[3]	IOU	SD1	SD Port 1 Data Bit 3
128	GPB[3]	IOU	GPIOB	GPIO Port B Bit 3
	I2S_BCLK	IU	I <sup>2</sup> S	I2S Interface Clock, Input
	SD1_CMD	IOU	SD1	SD Port 1 Command/Response

3.4.2 N9H20R11N TQFP64 pin list

Pin No	Name	Type	Group	Description
1	SPI0_CLK	IOU	SPI0	SPI Port 0 Clock;Output in Master Mode;Input in Slave Mode
	GPD[12]	IOU	GPIOD	GPIO Port D Bit 12
2	SPI0_CS0_	IOU	SPI0	SPI Port 0 Device Select 0, Low Active;Output in Master Mode;Input in Slave Mode
	GPD[13]	IOU	GPIOD	GPIO Port D Bit 13
3	SPI0_DI	IU	SPI0	SPI Port 0 Data Input
	GPD[14]	IOU	GPIOD	GPIO Port D Bit 14
4	SPI0_DO	OU	SPI0	SPI Port 0 Data Output
	GPD[15]	IOU	GPIOD	GPIO Port D Bit 15
5	XIN	I	XTAL	12MHz Crystal Input
6	XOUT	O	XTAL	12MHz Crystal Output
7	VDD18	P	Core	Core Logic Power (1.8V)
8	MVDD	P	MVDD	SDRAM Power (3.3V)
9	PLL_UD_VDD18	P	PLL & USB	PLL & USB2.0 Device Core Power (1.8V)
10	UD_DM	I/O	USB	USB 2.0 Device D-.
11	UD_DP	I/O	USB	USB 2.0 Device D+.
12	UD_VDD33	P	USB	USB 2.0 Device PHY 3.3V
13	UD_REXT	O	USB	External Resistor 12.1K resistor connected to ground
14	LVDATA[15]	IOU	LCD	SYNC/MPU LCD Interface Data Bit 15
	GPC[15]	IOU	GPIOC	GPIO Port C Bit 15
15	LVDATA[14]	IOU	LCD	SYNC/MPU LCD Interface Data Bit 14
	GPC[14]	IOU	GPIOC	GPIO Port C Bit 14
16	LVDATA[13]	IOU	LCD	SYNC/MPU LCD Interface Data Bit 13
	GPC[13]	IOU	GPIOC	GPIO Port C Bit 13
17	LVDATA[12]	IOU	LCD	SYNC/MPU LCD Interface Data Bit 12
	GPC[12]	IOU	GPIOC	GPIO Port C Bit 12
18	LVDATA[11]	IOU	LCD	SYNC/MPU LCD Interface Data Bit 11
	GPC[11]	IOU	GPIOC	GPIO Port C Bit 11
19	LVDATA[10]	IOU	LCD	SYNC/MPU LCD Interface Data Bit 10
	GPC[10]	IOU	GPIOC	GPIO Port C Bit 10
20	LVDATA[9]	IOU	LCD	SYNC/MPU LCD Interface Data Bit 9
	GPC[9]	IOU	GPIOC	GPIO Port C Bit 9
21	LVDATA[8]	IOU	LCD	SYNC/MPU LCD Interface Data Bit 8
	GPC[8]	IOU	GPIOC	GPIO Port C Bit 8

22	LVDATA[7]	IOU	LCD	SYNC/MPU LCD Interface Data Bit 7
	GPC[7]	IOU	GPIOC	GPIO Port C Bit 7
23	LVDATA[6]	IOU	LCD	SYNC/MPU LCD Interface Data Bit 6
	GPC[6]	IOU	GPIOC	GPIO Port C Bit 6
24	LVDATA[5]	IOU	LCD	SYNC/MPU LCD Interface Data Bit 5
	GPC[5]	IOU	GPIOC	GPIO Port C Bit 5
25	LVDATA[4]	IOU	LCD	GPIO Port C Bit 4
	GPC[4]	IOU	GPIOC	GPIO Port C Bit 4
26	LVDATA[3]	IOU	LCD	SYNC/MPU LCD Interface Data Bit 3
	GPC[3]	IOU	GPIOC	GPIO Port C Bit 3
27	LVDATA[2]	IOU	LCD	SYNC/MPU LCD Interface Data Bit 2
	GPC[2]	IOU	GPIOC	GPIO Port C Bit 2
28	LVDATA[1]	IOU	LCD	SYNC/MPU LCD Interface Data Bit 1
	GPC[1]	IOU	GPIOC	GPIO Port C Bit 1
29	LVDATA[0]	IOU	LCD	SYNC/MPU LCD Interface Data Bit 0
	GPC[0]	IOU	GPIOC	GPIO Port C Bit 0
30	LVDE	OU	LCD	SYNC LCD Interface Data Enable, Output, High Active
	LRS	OU	LCD	MPU LCD Interafec Register Select
	GPD[11]	IOU	GPIOD	GPIO Port D Bit 11
31	LVSYNC	OU	LCD	SYNC LCD Interface VSYNC, Output, High Active
	LRD	OU	LCD	MPU I80 mode LCD Interface Read, active low
	GPD[10]	IOU	GPIOD	LCD Interface Data Enable, High Active.
32	LHSYNC	OU	LCD	SYNC LCD Interface HSYNC, Output, High Active
	LWR	OU	LCD	MPU I80 mode LCD Interface Write, active low
	GPD[9]	IOU	GPIOD	GPIO Port D Bit 9
33	LPCLK	OU	LCD	SYNC LCD Interface Pixel Clock, Output
	LCS	OU	LCD	MPU LCD Interface Chip Enable, active low
	GPB[15]	IOU	GPIOB	GPIO Port B Bit 15
34	ADC_VDD33	P	ADC	ADC Power (3.3V)
35	RTC_VDD1.8V	P	RTC	RTC Power (1.8V)
36	VDD33	P	I/O	I/O Power (3.3V)
37	GPA[5]	IOU	GPIOA	GPIO Port A Bit 5
	SPI0_CS1_	OU	SPI0	SPI Port 0 Device Select 1, Output, Low Active
38	GPA[4]	IOU	GPIOA	GPIO Port A Bit 4
	UHL_DM1	IOU	USB	USB Host 1.0 Lite Port 1, D-
39	GPA[3]	IOU	GPIOA	GPIO Port A Bit 3

	UHL_DP1	IOU	USB	USB Host 1.0 Lite Port 1, D+
40	GPA[2]	IOU	GPIOA	GPIO Port A Bit 2
	LMVSYNC	OU	LCD	MPU LCD Interface VSYNC, Output
	LFMARK	IU	LCD	MPU LCD Interface Frame Mark, Input
41	RST_	IU	SYSTEM	System Reset, Input, Low Active
	WDT_RST_	OU	SYSTEM	Watch-Dog Reset, Output, Low Active
42	TCK	ID	JTAG	JTAG Interface Test Clock, Input
	GPD[0]	IOD	GPIOD	GPIO Port D Bit 0
	SPI1_CS1_	OD	SPI1	SPI Port 1 Device Select 1, Output, Low Active
	PWM0	OD	PWM	PWM Channel 0
43	TMS	IU	JTAG	JTAG Interface Test Mode Select, Input
	GPD[1]	IOU	GPIOD	GPIO Port D Bit 1
	HUR_TXD	OU	UART	High-Speed UART TX Data, Output
	PWM1	OU	PWM	PWM Channel 1
44	TDI	IU	JTAG	JTAG Interface Test Data In, Input
	GPD[2]	IOU	GPIOD	GPIO Port D Bit 2
	HUR_RXD	IU	UART	High-Speed UART RX Data, Input
	PWM2	OU	PWM	PWM Channel 2
45	TDO	OU	JTAG	JTAG Interface Test Data Out, Output
	GPD[3]	IOU	GPIOD	GPIO Port D Bit 3
	PWM3	OU	PWM	PWM Channel 3
46	TRST_	IU	JTAG	JTAG Interface Test Reset, Input, Low Active
	GPD[4]	IOU	GPIOD	GPIO Port D Bit 4
	SPI0_CS1_	OU	SPI0	SPI Port 0 Device Select 1, Output, Low Active
47	UD_CDET	I	USB	USB Device Connect Detect, Input, High Active
48	VDD18	P	Core	Core Logic Power (1.8V)
49	MVDD	P	MVDD	SDRAM I/O Power (3.3V)
50	VDDQ	P	MVDD	SDRAM Power (3.3V)
51	AVDD33	P	AUDIO	Audio DAC Power (3.3V)
52	VDD18	P	Core	Core Logic Power (1.8V)
53	GPA[7]	IOU	GPIOA	GPIO Port A Bit 7
	CFG[0]	OU	SYSTEM	Chip Power-On Configuration Bit [0], Input
54	GPD[6]	IOU	GPIOD	GPIO Port D Bit 6
	SD2_DAT[2]	IOU	SD2	SD Port 2 Data Bit 2
55	GPD[5]	IOU	GPIOD	GPIO Port D Bit 5
	SD2_DAT[3]	IOU	SD2	SD Port 2 Data Bit 3

56	GPD[8]	IOU	GPIOD	GPIO Port D Bit 8
	SD2_CMD	IOU	SD2	SD Port 2 Command/Response
57	GPD[7]	IOU	GPIOD	GPIO Port D Bit 7
	SD2_CLK	OU	SD2	SD Port 2 Clock, Output
58	GPE[9]	IOU	GPIOE	GPIO Port E Bit 9
	SD2_DAT[0]	IOU	SD2	SD Port 2 Data Bit 0
59	GPE[8]	IOU	GPIOE	GPIO Port E Bit 8
	SD2_DAT[1]	IOU	SD2	SD Port 2 Data Bit 1
60	VDD33	P	I/O	I/O Power (3.3V)
61	URTXD	OU	UART	UART TX Data, Output
	GPA[10]	IOU	GPIOA	GPIO Port A Bit 10
	SPI1_CS1_	OU	SPI1	SPI Port 1 Device Select 1, Output, Low Active
62	URRXD	IU	UART	UART RX Data, Input
	GPA[11]	IOU	GPIOA	GPIO Port A Bit 11
	LMVSYNC	OU	LCD	MPU LCD Interface VSYNC, Output
	LFMARK	IU	LCD	MPU LCD Interface Frame Mark, Input
63	ISDA	IOU	I2C	I2C Interface Data
	GPB[14]	IOU	GPIOB	GPIO Port B Bit 14
	LFMARK	IU	LCD	MPU LCD Interface Frame Mark, Input
	LMVSYNC	OU	LCD	MPU LCD Interface Mode VSYNC, Output
64	ISCK	OU	I2C	I2C Interface Clock, Output
	GPB[13]	IOU	GPIOB	GPIO Port B Bit 13
E-PAD	VSS	P	GND	Ground (0V)

Note:

TYPE	DESCRIPTION
I	Input
O	Output
I/O	Input / Output
IU	Input with internal pull high (50K)
OU	Output with internal pull high (50K)
IOU	Bi-direction with internal pull high (50K)
ID	Input with internal pull low (50K)
OD	Output with internal pull low (50K)
IOD	Bi-direction with internal pull low (50K)
P	Analog Power or Digital Power

G	Analog GND or Digital GND
---	---------------------------

nuvoTon Confidential

## 4 BLOCK DIAGRAM

### 4.1 N9H20 Series Block Diagram

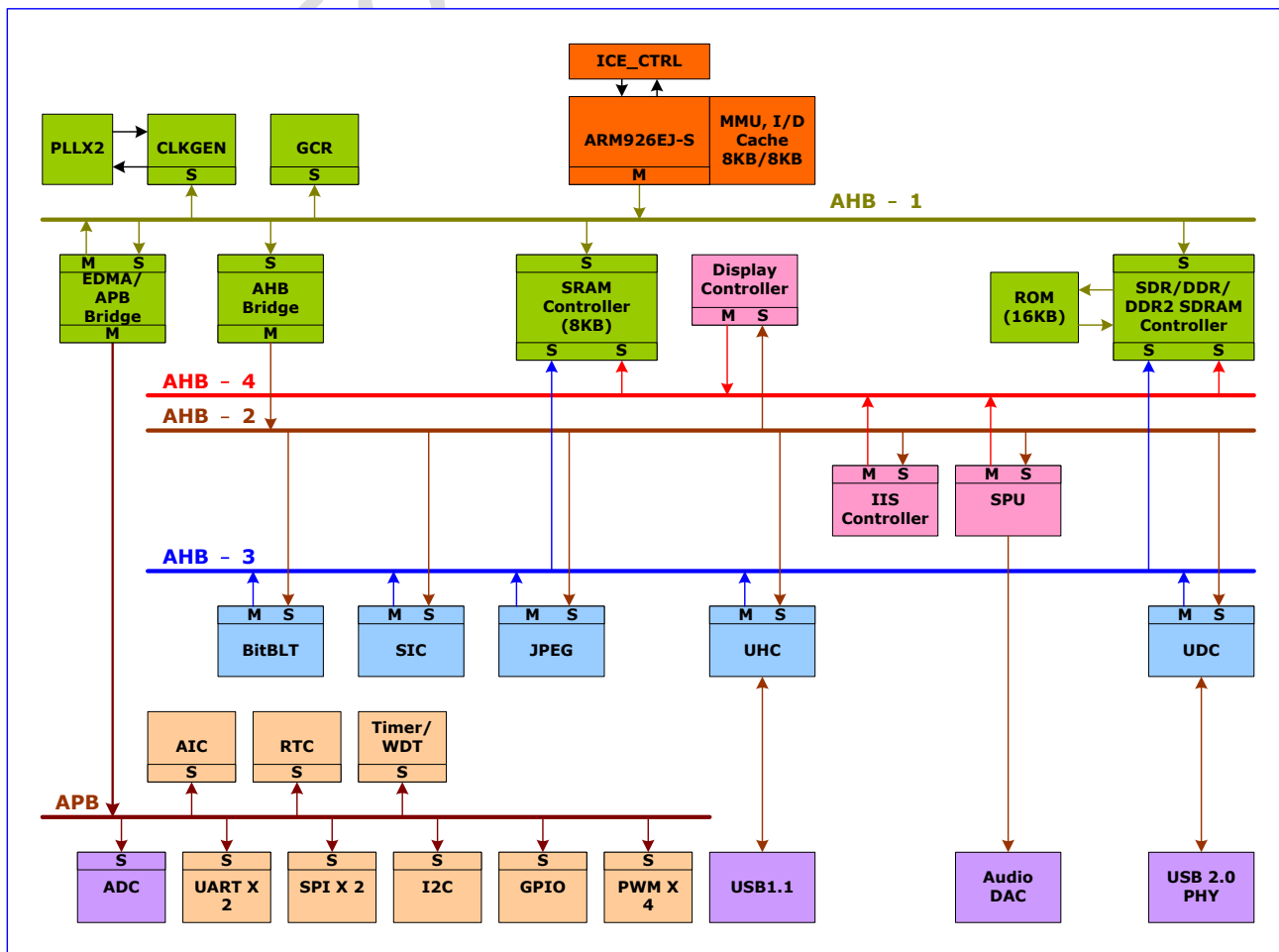

Figure 4.1 N9H20 Series Block Diagram

## 5 FUNCTIONAL DESCRIPTION

### 5.1 ARM® ARM926EJ-S CPU Core

#### 5.1.1 Overview

The ARM926EJ-S CPU core is a member of the ARM9 family of general-purpose microprocessors. The ARM926EJ-S CPU core is targeted at multi-tasking applications where full memory management, high performance, and low power are all important.

The ARM926EJ-S CPU core supports the 32-bit ARM and 16-bit Thumb instruction sets, enabling the user to choose between high performance and high code density.

The ARM926EJ-S processor provides support for external coprocessor enabling floating-point or other application-specific hardware acceleration to be added. The ARM926EJ-S CPU core implements ARM architecture version 5TEJ.

The ARM926EJ-S processor has a Harvard cached architecture and provides a complete high-performance processor subsystem, including:

- An ARM9EJ-S integer core.
- A Memory Management Unit (MMU).
- Separate instruction and data cache.
- Separate instruction and data AMBA AHB bus interfaces.

## 5.2 System Manager

### 5.2.1 Overview

The system management describes following information and functions.

- System Memory Map
- Power-On Setting
- Bus Arbitration Mode
- Power Management
- IBR (Internal Boot ROM) Sequence
- System management registers for product ID, functional reset and multi-function pin control.

## 5.3 Clock Controller (CLK\_CTL)

### 5.3.1 Overview

The clock controller generates the clocks for the whole chip, it include all of IPs on AHB, APB and engine clock like USB, UART and so on. There are a PLL in this chip, and the PLL clock source is from the external crystal input. It also implements the power control function, include the individually clock on or off control register, clock source selector and divider. These functions minimize the extra power consumption and the chip run on the only just condition. On the power down mode the controller turn off the crystal oscillator to minimize the chip power consumption.

## 5.4 SDRAM Interface Controller (SDIC)

### 5.4.1 Overview

The SDRAM Controller support SDR, DDR, Low-Power DDR and DDR2 type SDRAM. The memory device size type can be from 16M bit and up to 1G bits. Only 16-bit data bus width is supported. The total system memory size can be from 2M-byte and up to 32M-byte for different SDRAM configuration.

## 5.5 2D Blitting Accelerator

### 5.5.1 Overview

The 2D blitting accelerator features are built on top of the FlashLite Bitmap rendering feature. It improves rendering performance of bitmap objects (source image) onto the frame buffer (destination image).

There are two functions support. First is BitBLT function with effects of Scale, Rotate, Shear and Reflect. The second is Fill function to fill a rectangle in the frame buffer.

## 5.6 JPEG Codec (JPEG)

### 5.6.1 Overview

The JPEG Codec supports Baseline Sequential Mode JPEG still image compression and decompression that is fully compliant with ISO/IEC International Standard 10918-1 (T.81).

## 5.7 LCD Display Interface Controller (VPOST)

### 5.7.1 Overview

The main purpose of Display Controller is used to display the video/image data to LCD device or connect with external TV-encoder. The video/image data source may come from the JPEG decoder and the OSD pattern which have been stored in system memory (SDRAM). The input data format of the display controller can be packet YUV422, packet YUV444, packet RGB444, packet RGB565, packet RGB666, and packet RGB888. The OSD (On Screen Display) function supports packet YUV422 and 8/16/24-bit direct-color mode. The LCD controller supports both sync-type and MPU-type LCDM. This LCD Controller is a bus master and can transfer display data from system memory (SDRAM) without CPU intervention.

## 5.8 Sound Processing Unit (SPU)

### 5.8.1 Overview

The SPU performs 32 channels audio input and 16-bit stereo output to DAC and I2S. SPU support 3 data-types (E-MDPCM (4bit), PCM16, LP8) with event and raw PCM16 mono/stereo and Tone.

## 5.9 I<sup>2</sup>S Controller (I<sup>2</sup>S)

### 5.9.1 Overview

The audio controller consists of I2S protocols to interface with external audio CODEC. The I2S interface supports 16, 18, 20 and 24-bit left/right precision in record and playback. When operating in 18/20/24-bit precision, each left/right-channel sample is stored in a 32-bit word. Each left/right-channel sample has 24/20/18 MSB bits of valid data and other LSB bits are the padding zeros. When operating in 16-bit precision, right-channel sample is stored in MSB of a 32-bit word and left-channel sample is stored in LSB of a 32-bit word.

## 5.10 Storage Interface Controller

### 5.10.1 Overview

The Storage Interface Controller (SIC) has SIC\_DMA unit and SIC\_FMI unit. The SIC\_DMAM unit provides a DMA (Direct Memory Access) function for FMI to exchange data between system memory (ex. SDRAM) and shared buffer (128 bytes), and the SIC\_FMI unit control the interface of SD/SDHC/SDIO/MMC or NAND/SM. The serial interface controller can support SD/SDHC/SDIO/MMC card and NAND-type flash and the FMI is cooperated with DMAC to provide a fast data transfer between system memory and cards.

## 5.11 USB 2.0 Device Controller (USBD)

### 5.11.1 Overview

The USB device controller interfaces the AHB bus and the UTMI bus. The USB controller contains both the AHB master interface and AHB slave interface. CPU programs the USB controller registers through the AHB slave interface. For IN or OUT transfer, the USB device controller needs to write data to memory or read data from memory through the AHB master interface. The USB device controller is compliant with USB 2.0 specification and it contains four configurable endpoints in addition to control endpoint. These endpoints could be configured to BULK, INTERRUPT or ISO. The USB device controller has a built-in DMA to relieve the load of CPU.

## 5.12 USB Host Controller (USBH)

### 5.12.1 Overview

The Universal Serial Bus (USB) is a low-cost, low-to mid-speed peripheral interface standard intended for modem, scanners, PDAs, keyboards, mice, and other devices that do not require a high-bandwidth parallel interface. The USB is a 4-wire serial cable bus that supports serial data exchange between a Host Controller and a network of peripheral devices. The attached peripherals share USB bandwidth through a host-scheduled, token-based protocol. Peripherals may be attached, configured, used, and detached, while the host and other peripherals continue operation (i.e. hot plug and unplug is supported).

## 5.13 Enhanced DMA Controller

### 5.13.1 Overview

The N9H20 contains an enhanced direct memory access (EDMA) controller that transfers data to and from memory or transfer data to and from APB. The EDMA controller has five-channel DMA that include a one channel VDMA (Video-DMA, Memory-to-Memory) and four channels PDMA (Peripheral-to-Memory or Memory-to-Peripheral). For channel0 VDMA mode, it also support color format transform and stripe mode transfer. For PDMA channel (EDMA CH1~CH4), it can transfer data between the Peripherals APB IP (ex: UART, SPI, ADC...) and Memory.

The N9H20 also support hardware scatter-gather function, software can set CSRx [SG\_EN] to enable scatter-gather function.

## 5.14 Advanced Interrupt Controller (AIC)

### 5.14.1 Overview

An interrupt temporarily changes the execution sequence of a program to react to a particular event such as power failure, watchdog timer timeout, and engine complete, system events, external event trigger and so on. The ARM9 processor provides two modes of interrupts, the Fast Interrupt (FIQ) mode for critical session and the Interrupt (IRQ) mode for general purpose. The IRQ exception mode is occurred when the NIRQ input is asserted. Similarly, the FIQ exception mode is occurred when the NFIQ input is asserted. The FIQ mode has privilege over the IRQ mode and can preempt an ongoing IRQ mode. It is possible to ignore the NFIQ and the NIRQ by setting the F-bit and I-bit in the current program status register (CPSR).

## 5.15 General Purpose I/O (GPIO)

### 5.15.1 Overview

General Purpose I/O are shared with special feature functions.

Supported Features of these I/O are: input or output facilities, pull-up resistors.

All these general purpose I/O functions are achieved by software programming setting and I/O cells selected from SMIC universal standard I/O Cell Library. And the following figures illustrate the control mechanism to achieve the GPIO functions.

## 5.16 Timer Controller (TMR)

### 5.16.1 Overview

The timer module includes four channels, TIMER0~TIMER3, which allow you to easily implement a counting scheme for use. The timer can perform functions like frequency measurement, event counting, interval measurement, clock generation, delay timing, and so on. The timer possesses features such as adjustable resolution, programmable counting period, and detailed information. The timer can generate an interrupt signal upon timeout, or provide the current value of count during operation.

## 5.17 Watchdog Timer (WDT)

### 5.17.1 Overview

The purpose of Watchdog Timer (WDT) is to perform a system reset when system runs into an unknown state. This prevents system from hanging for an infinite period of time. Besides, this Watchdog Timer supports the function to wake-up system from Idle/Power-down mode.

## 5.18 Real Time Clock (RTC)

### 5.18.1 Overview

Real Time Clock (RTC) block can be operated by independent power supply while the system power is off. The RTC uses a 32.768 KHz external crystal. It can transmit data to CPU with BCD values. The data includes the time by (second, minute and hour), the day by (day, month and year). In addition, to achieve better frequency accuracy, the RTC counter can be adjusted by software.

The built in RTC is designed to generate the alarm interrupt and periodic interrupt signals. The period interrupt can be 1/128, 1/64, 1/32, 1/16, 1/8, 1/4, 1/2 and 1 second. The alarm interrupt indicates that time counter and calendar counter have counted to a specified time recorded in TAR and CAR.

## 5.19 I<sup>2</sup>C Synchronous Serial Interface Controller (I<sup>2</sup>C)

### 5.19.1 Overview

I2C is a two-wire, bi-directional serial bus that provides a simple and efficient method of data exchange between devices. The I2C standard is a true multi-master bus including collision detection and arbitration that prevents data corruption if two or more masters attempt to control the bus simultaneously.

Serial, 8-bit oriented bi-directional data transfers can be made up to 100 Kbit/s in Standard-mode, and 400 Kbit/s in the Fast-Mode. or up to 3.4 Mbit/s in the High-speed mode. Only 100kbps and 400kbps modes are supported directly. For High-speed mode special IOs are needed. If these IOs are available and used, then High-speed mode is also supported.

## 5.20 Pulse Width Modulation (PWM)

### 5.20.1 Overview

There are 4 PWM-Timers. The 4 PWM-Timers has 2 Pre-scale, 2 clock divider, 4 clock selectors, 4 16-bit counters, 4 16-bit comparators, 2 Dead-Zone generators. They are all driven by system clock. Each can be used as a timer and issues interrupt independently.

## 5.21 UART Interface Controller (UART)

### 5.21.1 Overview

The N9H20K provides two channels of Universal Asynchronous Receiver/Transmitters (UART). UART0 supports High Speed UART and UART1 perform Normal Speed UART, besides, only UART0 support flow control function.

The Universal Asynchronous Receiver/Transmitter (UART) performs a serial-to-parallel conversion on data characters received from the peripheral, and a parallel-to-serial conversion on data characters received from the CPU. Each UART channel supports six types of interrupts including transmitter FIFO empty interrupt (Int\_THRE), receiver threshold level reaching interrupt (Int\_RDA), line status interrupt (overrun error or parity error or framing error or break interrupt) (Int\_RLS), time out interrupt (Int\_Tout), MODEM status interrupt (Int\_Modem) and Wake up status interrupt (Int\_WakeUp).

## 5.22 SPI Interface Controller (SPI Master/Slaver)

### 5.22.1 Overview

The MICROWIRE/SPI Synchronous Serial Interface performs a serial-to-parallel conversion on data characters received from the peripheral, and a parallel-to-serial conversion on data characters received from CPU. This interface can drive up to 2 external peripherals and is seen as the master or can be driven as the slave.

It can generate an interrupt signal when data transfer is finished and can be cleared by writing 1 to the interrupt flag. The active level of device/slave select signal can be chosen to low active or high active, which depends on the peripheral it's connected. Writing a divisor into DIVIDER register can program the frequency of serial clock output when it is as the master. This master/slave core contains four 32-bit transmit/receive buffers, and can provide burst mode operation. The maximum bits can be transmitted/received is 32 bits, and can transmit/receive data up to four times successively.

There is EDMA mode for transmit or received data access by enable the EDMA bit in SPI\_EDMA[0]

## 5.23 Analog to Digital Converter (ADC)

### 5.23.1 Overview

The 10-bit analog to digital converter (ADC) in this chip is a successive approximation type ADC with 3-channel inputs. It needs 34 cycles to convert one sample, the maximum conversion rate is 500K/sec, so the maximum input clock to ADC is 17MHz, so and the operating voltage range is 3.3V +/- 10%. The power down mode is supported in the ADC.

The touch screen interfaces are supported in this chip, it contains 4-wire resistive touch screen. The four switches to bias XP, XM, YP, YM are embedded in this chip. The CPU could access the ADC control register by APB bus, and the ADC output an interrupt signal to AIC to represent the completion of conversion.

## 5.24 Keypad Interface (KPI)

### 5.24.1 Overview

The KPI supports release multiple keys, press multiple keys scan interrupt and specified INT\_3KEYs interrupt for chip reset. If the 3 pressed keys matches with the 3 keys defined in KPI3KCONF, it will generate an interrupt and chip reset (ENRST must setting) depend on the ENRST setting. The interrupt is generated whenever it detects any key in the keypad pressing or releasing or waking up from IDLE or three-key reset. User can know the interrupt source by querying KPISTATUS register.

## 6 ELECTRICAL CHARACTERISTICS

### 6.1 Absolute Maximum Ratings

Parameters	Values
Ambient Temperature	-20 °C ~ 85 °C
Storage Temperature	-40 °C ~ 125 °C
Voltage On Any Pin	-0.3V ~ 3.6V
Power Supply Voltage (Core Logic)	-0.5V ~ 1.5V
Power Supply Voltage (I/O Buffer)	-0.5V ~ 4.6V
Injection Current (Latch-Up Testing)	100mA
Crystal Frequency	1MHz ~ 27MHz

**Note:** Exposure to conditions beyond those listed under absolute maximum ratings may adversely affects the lift and reliability of the device.

## 6.2 DC Electrical Characteristics

### 6.2.1 N9H20 Series DC Electrical Characteristics

(VDD-VSS=3.3 V, TA = 25°C, FOSC = 12 MHz unless otherwise specified.)

Symbol	Parameter		Condition	Min.	Typ.	Max.	Unit
VDD33	I/O Buffer Post-Driver Voltage			3.0	3.3	3.6	V
MVDD33	SDRAM Operation Voltage (for N9H20K11N)		SDRAM_CLK=96MHz	3.0	3.3	3.6	V
MVDD18	DDR Operation Voltage (for N9H20K31N or N9H20K51N)		DDR_CLK=96MHz	1.7	1.8	1.9	
VDD18	Core Logic and I/O Buffer Pre-Driver Voltage		CPU_CLK=192MHz	1.7	1.8	1.9	V
RTC_VDD	RTC Power Supply			1.2	-	1.8	V
I <sub>RTC_VDD</sub>	RTC Supply Current		RTC_VDD ≤ 1.8V	-	4	-	uA
V <sub>IH</sub>	Input High Voltage			2.0	-	5.5	V
V <sub>IL</sub>	Input Low Voltage			-0.3	-	0.8	V
V <sub>T</sub>	Threshold Point			1.45	1.58	1.74	V
V <sub>T+</sub>	Schmitt Trigger Low to High Threshold Point			1.44	1.50	1.56	V
V <sub>T-</sub>	Schmitt Trigger High to Low Threshold Point			0.89	0.94	0.99	V
I <sub>CC</sub>	Core Power Supply Current		F <sub>CPU</sub> = 192MHz, MCLK = 96Hz, VDD18 = 1.8V	-	140	-	mA
I <sub>L</sub>	Input Leakage Current			-10	-	10	uA
I <sub>OZ</sub>	Tri-State Output Leakage Current			-10	-	10	uA
R <sub>PU</sub>	Pull-Up Resistor			39	65	116	kΩ
R <sub>PD</sub>	Pull-Down Resistor			40	56	108	kΩ
V <sub>OL</sub>	Output Low Voltage			-	-	0.4	V
V <sub>OH</sub>	Output High Voltage			2.4	-	-	V
I <sub>OL</sub>	Low Level Output Current	4mA I/O	V <sub>OL</sub> = 0.4V	-	4.0	-	mA
I <sub>OH</sub>	High Level Output	4mA I/O	V <sub>OH</sub> = 2.4V	-	5.9	-	mA

	Current						
--	---------	--	--	--	--	--	--

6.2.2 ADC Characteristics

Parameter	Min.	Typ.	Max.	Unit
SAR ADC Input Voltage Range	3.0	-	3.6	V
Resolution of ADC	-	-	10	bit
Signal-to-Noise Plus Distortion of ADC from Line In	-	TBD	-	dB
Integral Non-Linearity of ADC	-	±2.0	-	LSB
Differential Non-Linearity of ADC	-	±0.8	-	LSB
No Missing Code	-	10	-	bit
AD Conversion Rate=ADCCLK/16	-	-	400	KHz

6.2.3 Audio DAC Characteristics

Parameter	Min	Typ	Max	Unit
Operating Voltage	3.0	3.3	3.6	V
Reference Voltage	-	DAC_VDD/2	-	V
Reference Capacitor	-	0.1	-	uF
Full Scale output voltage	-	0.74	-	Vrms
Full Scale output voltage	-	2.08	-	Vpp
Maximum Output Power	-	-	52	mW
Maximum Output Power @ 32ohm load	-	-	46	mW
Maximum Output Power @ 16ohm load	-	-	41	mW
L-Channel SNR	-	86	-	dBV
R-Channel SNR	-	85	-	dBV
L-Channel THD+N	-	-64	-	dB
R-Channel THD+N	-	-64	-	dB
L-Channel THD+N @ 32ohm load	-	-63	-	dB
R-Channel THD+N @ 32ohm load	-	-63	-	dB
L-Channel THD+N @ 16ohm load	-	-62	-	dB

R-Channel THD+N @ 16ohm load	-	-62	-	dB
------------------------------	---	-----	---	----

Test conditions: RL = 10K / 50pF, BW = 20Hz ~ 20KHz, Freq.= 1KHz, Sample Rate = 48KHz.

### 6.3 AC Electrical Characteristics

#### 6.3.1 External 12 MHz Crystal

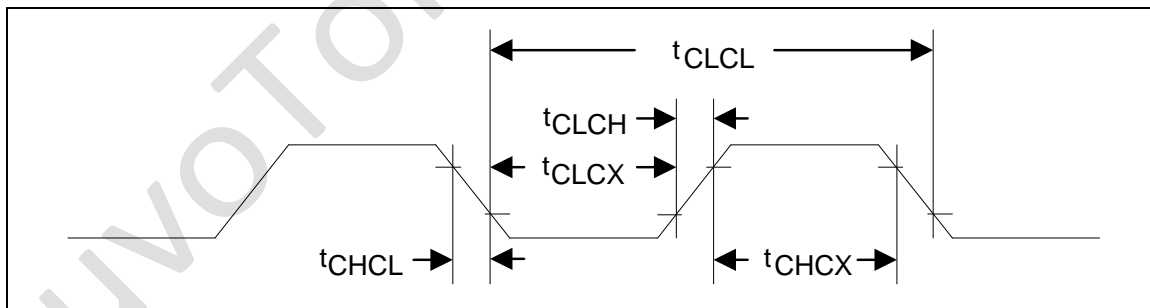

**Note:** Duty cycle is 50%.

PARAMETER	SYMBOL	MIN.	TYP.	MAX.	UNITS	CONDITION
Clock High Time	$t_{CHCX}$	20	-	125	nS	
Clock Low Time	$t_{CLCX}$	20	-	125	nS	
Clock Rise Time	$t_{CLCH}$	-	-	10	nS	
Clock Fall Time	$t_{CHCL}$	-	-	10	nS	

Symbol	Parameter	Min.	Typ.	Max.	Unit
$F_{XIN}$	Clock Input Frequency	-	12	-	MHz
$XIN_{DUTY}$	Clock Input Duty Cycle	45	50	55	%

### 6.3.2 Power-on Sequence & RESET

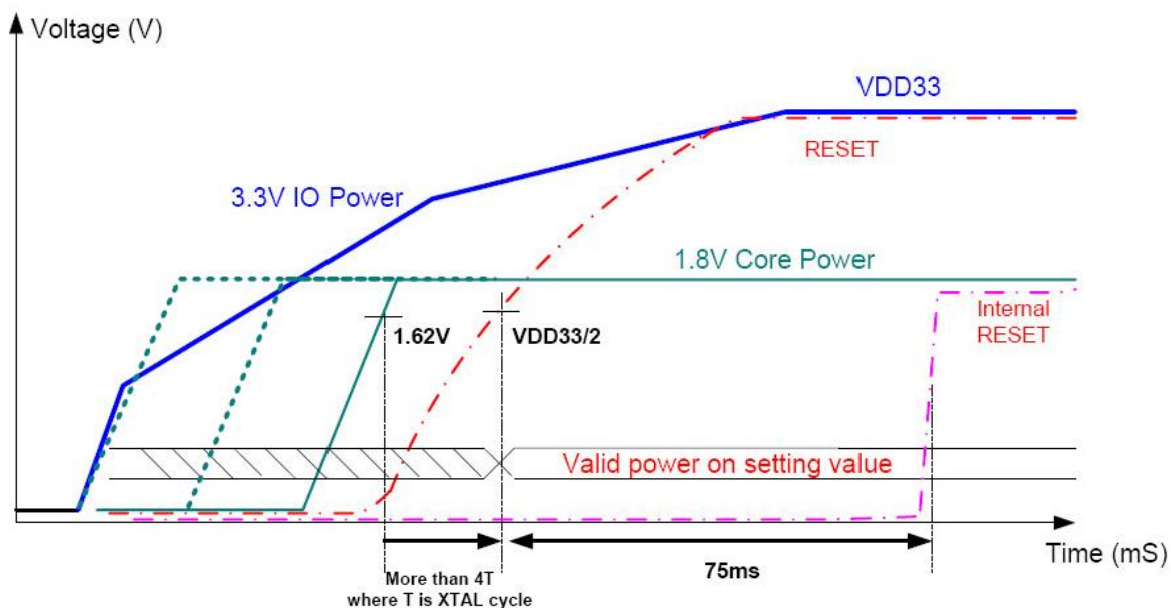

#### 6.3.2.1 Power up sequence

- Higher Voltage IO (3.3V) First
- Sequence:  $T_{33} \geq T_{18}$  (The time of delay gap between  $< 500\mu\text{s}$  is prefer)

#### 6.3.2.2 Power down Sequence

- The lower voltage (1.8V) should be powered down first
- Sequence:  $T_{18} \geq T_{33}$

#### Note.

- T18 represents 1.8V powered time for Core power
- T33 represents 3.3V powered time for I/O power

6.3.3 I2C Interface

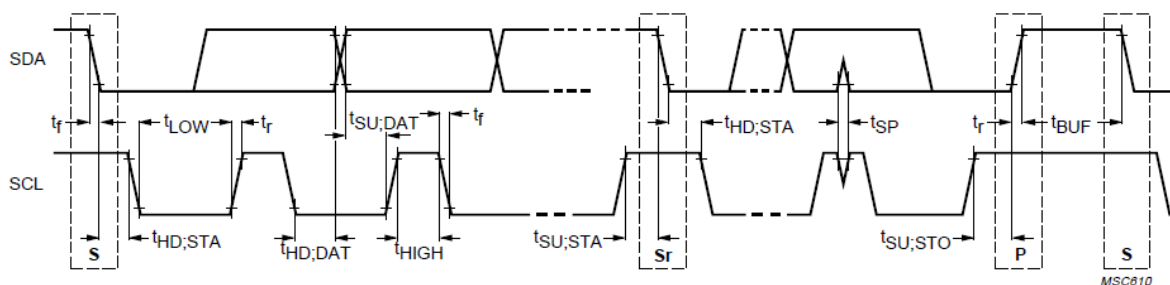

PARAMETER	SYMBOL	STANDARD-MODE		FAST-MODE		UNIT
		MIN.	MAX.	MIN.	MAX.	
SCL clock frequency	$f_{SCL}$	0	100	0	400	kHz
Hold time (repeated) START condition. After this period, the first clock pulse is generated	$t_{HD;STA}$	4.0	–	0.6	–	$\mu$ s
LOW period of the SCL clock	$t_{LOW}$	4.7	–	1.3	–	$\mu$ s
HIGH period of the SCL clock	$t_{HIGH}$	4.0	–	0.6	–	$\mu$ s
Set-up time for a repeated START condition	$t_{SU;STA}$	4.7	–	0.6	–	$\mu$ s
Data hold time: for CBUS compatible masters (see NOTE, Section 10.1.3) for I <sup>2</sup> C-bus devices	$t_{HD;DAT}$	5.0 0 <sup>(2)</sup>	– 3.45 <sup>(3)</sup>	– 0 <sup>(2)</sup>	– 0.9 <sup>(3)</sup>	$\mu$ s $\mu$ s
Data set-up time	$t_{SU;DAT}$	250	–	100 <sup>(4)</sup>	–	ns
Rise time of both SDA and SCL signals	$t_r$	–	1000	$20 + 0.1C_b^{(5)}$	300	ns
Fall time of both SDA and SCL signals	$t_f$	–	300	$20 + 0.1C_b^{(5)}$	300	ns
Set-up time for STOP condition	$t_{SU;STO}$	4.0	–	0.6	–	$\mu$ s
Bus free time between a STOP and START condition	$t_{BUF}$	4.7	–	1.3	–	$\mu$ s
Capacitive load for each bus line	$C_b$	–	400	–	400	pF
Noise margin at the LOW level for each connected device (including hysteresis)	$V_{nL}$	$0.1V_{DD}$	–	$0.1V_{DD}$	–	V
Noise margin at the HIGH level for each connected device (including hysteresis)	$V_{nH}$	$0.2V_{DD}$	–	$0.2V_{DD}$	–	V

6.3.4 I2S Interface

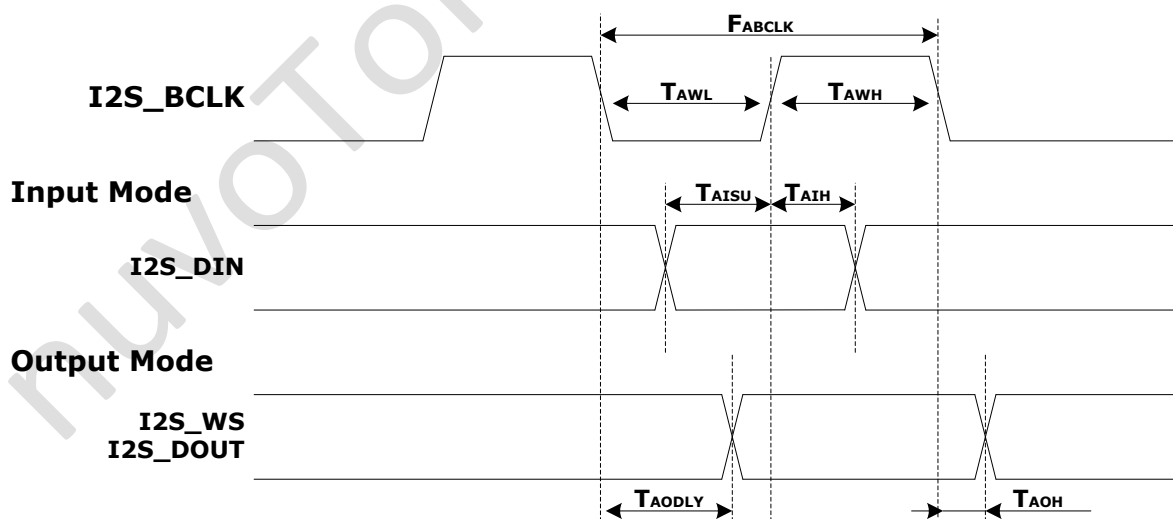

Symbol	Parameter	Min.	Typ.	Max.	Unit
$F_{ABCLK}$	I2S_BCLK Clock Frequency	-	-	16	MHz
$T_{AWL}$	I2S_BCLK Clock Low Time	31.25	-	-	ns
$T_{AWH}$	I2S_BCLK Clock High Time	31.25	-	-	ns
$T_{AISU}$	I2S_DIN Setup Time	10	-	-	ns
$T_{AIH}$	I2S_DIN Hold Time	10	-	-	ns
$T_{AODLY}$	I2S_DOUT Output Delay Time	-	-	0.5	ns
$T_{AOH}$	I2S_DOUT Output Hold Time	0.1	-	-	ns

6.3.5 LCD/ Display Interface

**SYNC Type LCD**

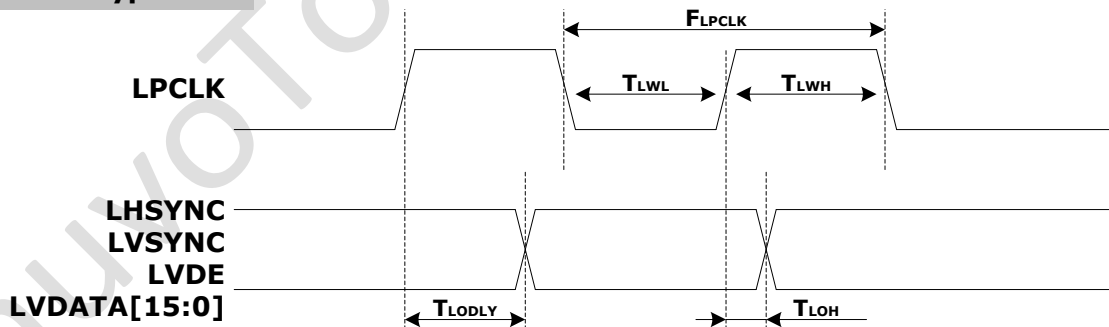

Symbol	Parameter	Min.	Typ.	Max.	Unit
$F_{LPCLK}$	LPCLK Clock Frequency	-	-	27	MHz
$T_{LWL}$	LPCLK Clock Low Time	18.5	-	-	ns
$T_{LWH}$	LPCLK Clock High Time	18.5	-	-	ns
$T_{LODLY}$	LHSYNC, LVSYNC, LVDE and LVDATA Output Delay Time	-	-	1.3	ns
$T_{LOH}$	LHSYNC, LVSYNC, LVDE and LVDATA Output Hold Time	0.67	-	-	ns

**MPU Type LCD**

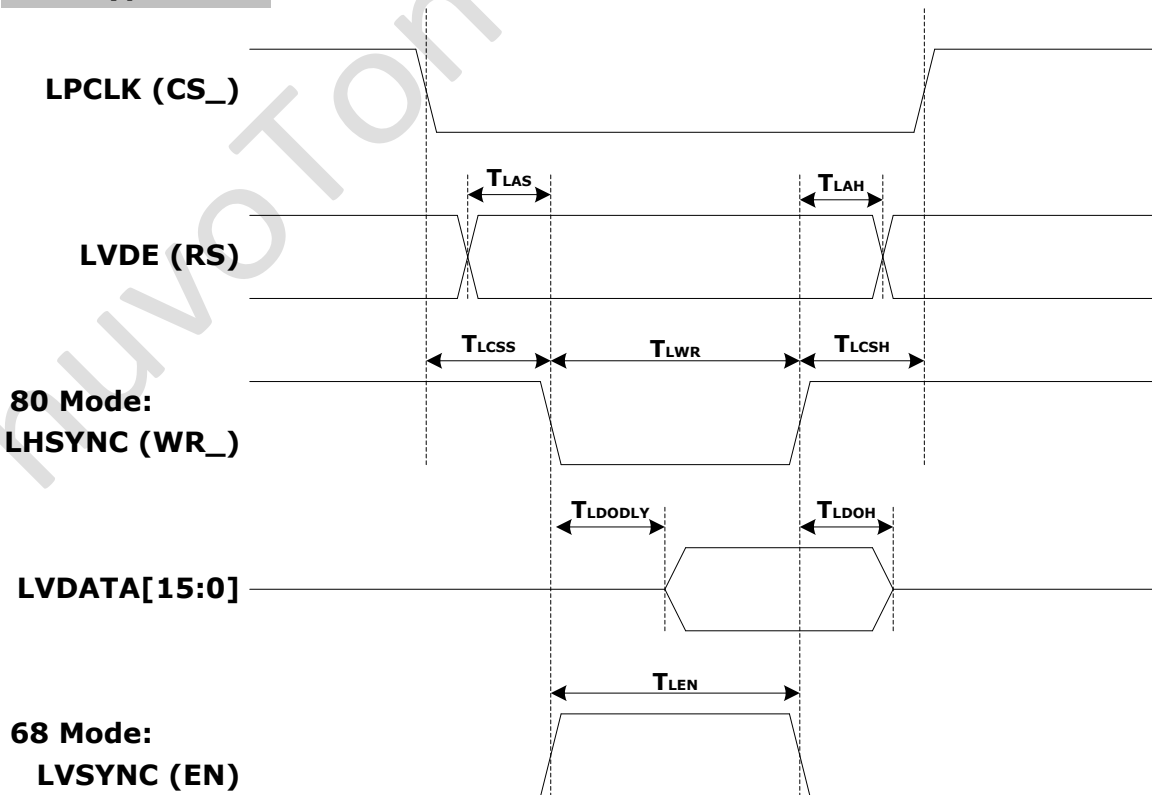

Symbol	Parameter	Condition	Min.	Typ.	Max.	Unit
$T_{LCSS}$	CS_ to WR_ Setup Time		2	-	-	PCLK
$T_{LASH}$	CS_ to WR_ Hold Time		1	-	-	PCLK
$T_{LAS}$	RS to WR_ Setup Time		1	-	-	PCLK
$T_{LAH}$	RS to WR_ Hold Time		1	-	-	PCLK
$T_{LDODLY}$	LVDATA Output Delay Time		-	-	1	PCLK
$T_{LDOH}$	LVDATA Output Hold Time		1	-	-	PCLK
$T_{LWR}$	WR_ Pulse Width	80 Mode	1	-	-	PCLK
$T_{LEN}$	EN Pulse Width	68 Mode	1	-	-	PCLK

Note: Where PCLK is APB bus clock.

6.3.6 SPI Interface

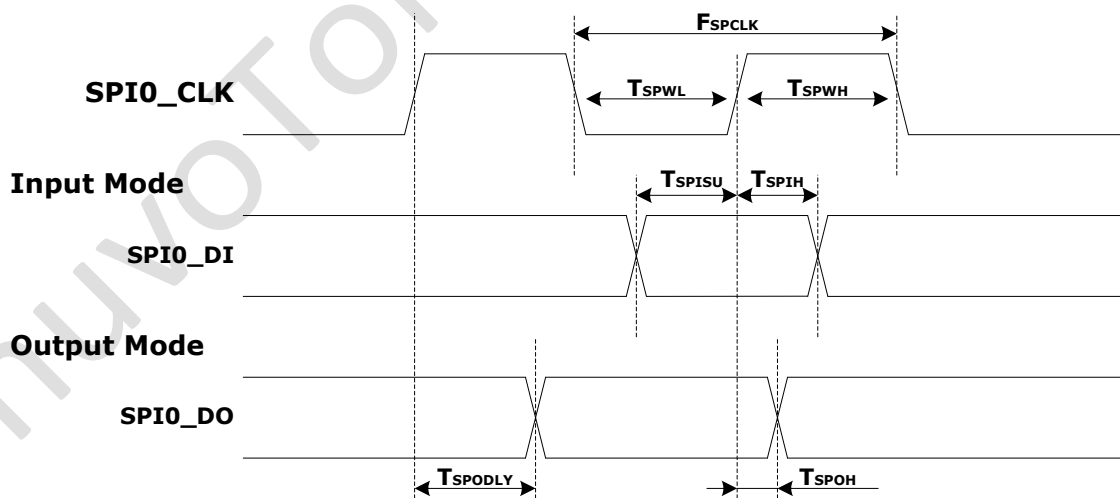

Symbol	Parameter	Min.	Typ.	Max.	Unit
$F_{SPCLK}$	SPI0_CLK Clock Frequency	-	-	25	MHz
$T_{SPWL}$	SPI0_CLK Clock Low Time	20	-	-	ns
$T_{SPWH}$	SPI0_CLK Clock High Time	20	-	-	ns
$T_{SPISU}$	SPI0_DI Setup Time	10	-	-	ns
$T_{SPIH}$	SPI0_DI Hold Time	10	-	-	ns
$T_{SPODLY}$	SPI0_DO Output Delay Time	-	-	1	ns
$T_{SPOH}$	SPI0_DO Output Hold Time	0.2	-	-	ns

6.3.7 NAND Interface

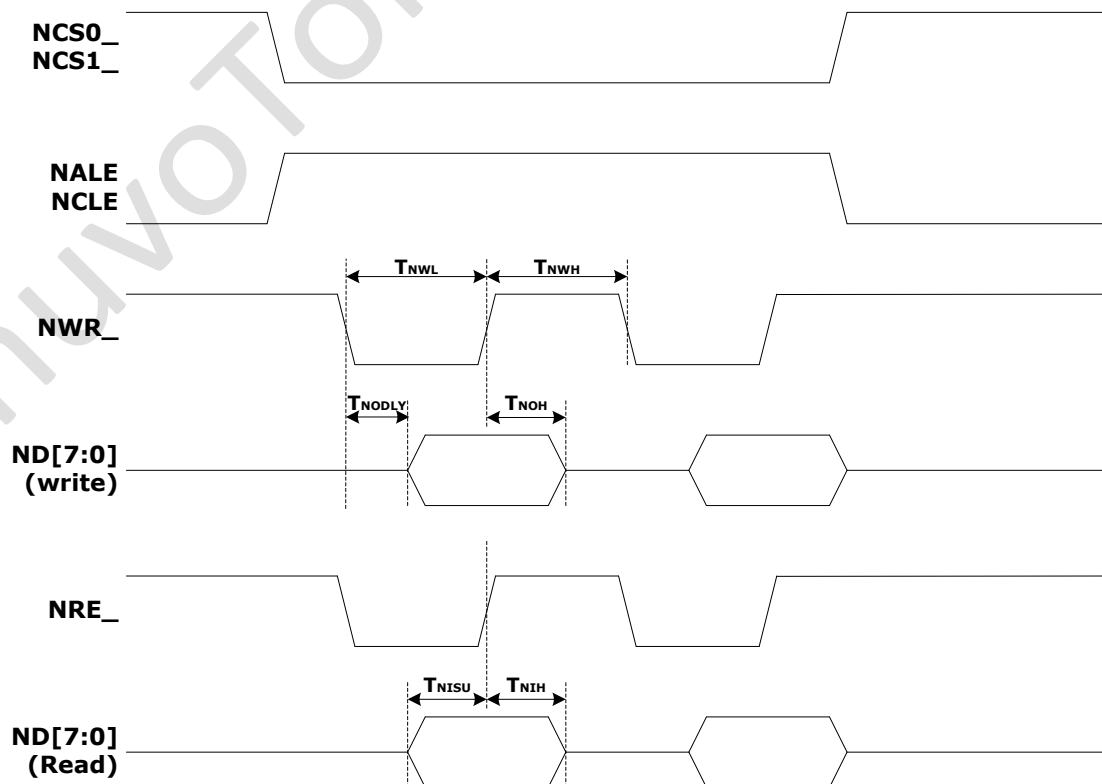

Symbol	Parameter	Min.	Typ.	Max.	Unit
$T_{NWL}$	Write Pulse Low Width	10	-	-	ns
$T_{NWH}$	NWR_ High Hold Time	10	-	-	ns
$T_{NODLY}$	ND[7:0] Output Delay Time	-	-	2.5	ns
$T_{NOH}$	ND[7:0] Output Hold Time	10	-	-	ns
$T_{NISU}$	ND[7:0] Data in Setup Time	3.2	-	-	ns
$T_{NIH}$	ND[7:0] Data in hold time	1	-	-	ns

6.3.8 SD Card Interface

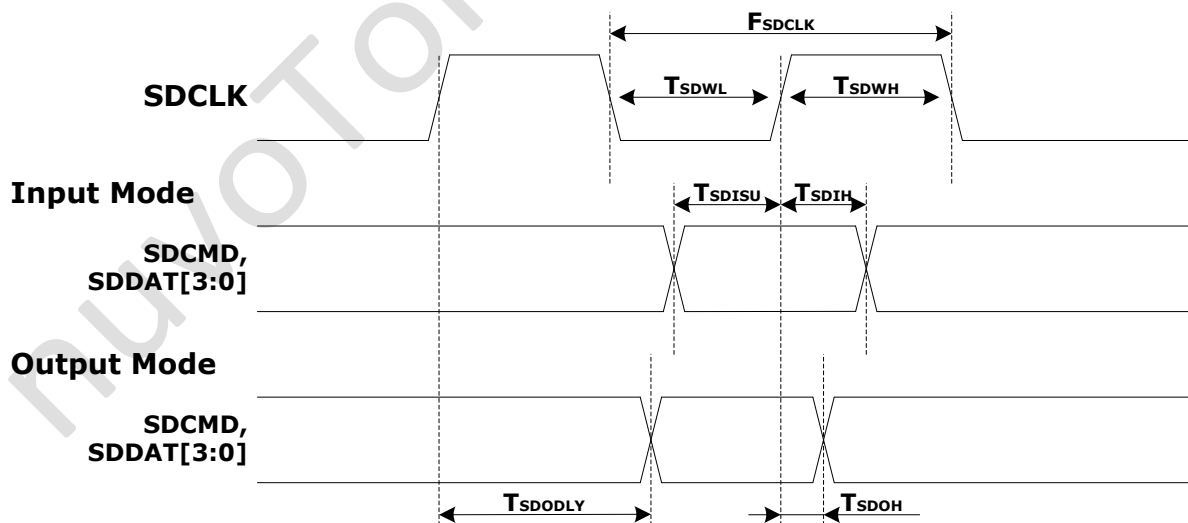

Symbol	Parameter	Min.	Typ.	Max.	Unit
<b>Clock SDCLK</b>					
$F_{SDCLK}$	Clock Frequency in Data Transfer Mode	-	-	24	MHz
$F_{SDCLK}$	Clock Frequency in Identification Mode	100	-	400	KHz
$T_{SDWL}$	Clock Low Time	10	-	-	ns
$T_{SDWH}$	Clock High Time	10	-	-	ns
<b>Input SDCMD, SDDAT[3:0] (referenced to SDCLK)</b>					
$T_{SDISU}$	Input Setup Time	6	-	-	ns
$T_{SDIH}$	Input Hold Time	2	-	-	ns
<b>Output SDCMD, SDDAT[3:0] (referenced to SDCLK)</b>					
$T_{SDODLY}$	Output Delay Time	-	-	14	ns
$T_{SDOH}$	Output Hold Time	2.5	-	-	ns

### 6.3.9 USB PHY Specifications

#### 6.3.9.1 USB DC Electrical Characteristics

Symbol	Parameter	Conditions	Min.	Typ	Max.	Unit
V <sub>IH</sub>	Input high (driven)		2.0	-	-	V
V <sub>IL</sub>	Input low		-	-	0.8	V
V <sub>DI</sub>	Differential input sensitivity	PADP-PADM	0.2	-	-	V
V <sub>CM</sub>	Differential common-mode range	Includes VDI range	0.8	-	2.5	V
V <sub>SE</sub>	Single-ended receiver threshold		0.8	-	2.0	V
	Receiver hysteresis		-	400	-	mV
V <sub>OL</sub>	Output low (driven)		0	-	0.3	V
V <sub>OH</sub>	Output high (driven)		2.8	-	3.6	V
V <sub>CRS</sub>	Output signal cross voltage		1.3	-	2.0	V
R <sub>PU</sub>	Pull-up resistor		1.425	-	1.575	kΩ
V <sub>TRM</sub>	Pull-down resistor		14.25	-	15.75	kΩ
Z <sub>DRV</sub>	Termination Voltage for upstream port pull up (RPU)		3.0	-	3.6	V
C <sub>IN</sub>	Driver output resistance	Steady state drive*	28	-	49.5	Ω
V <sub>IH</sub>	Transceiver capacitance	Pin to V <sub>SS</sub>	-	-	20	pF

Note: Driver output resistance does not include series resistor resistance.

#### 6.3.9.2 USB Full-Speed Driver Electrical Characteristics

Symbol	Parameter	Conditions	Min.	Typ	Max.	Unit
T <sub>FR</sub>	Rising time	CL = 50p	4	-	20	ns
T <sub>FF</sub>	Falling time	CL = 50p	4	-	20	ns

#### 6.3.9.3 USB High-Speed Driver Electrical Characteristics

Symbol	Parameter	Conditions	Min.	Typ	Max.	Unit
T <sub>FR</sub>	Rising time	CL = 5p	500			ps
T <sub>FF</sub>	Falling time	CL = 5p	500			ps

**6.3.10 Specification of Low Voltage Reset**

Parameter	Conditions	Min.	Typ	Max.	Unit
Operation voltage	-20°C ~ +85°C	2	3.3	3.6	V
LVR Detect Levels	VDD rises	2.16	2.4	2.64	V
	VDD falls	2.115	2.35	2.585	V

6.4 Thermal Characteristics of N9H20K Package

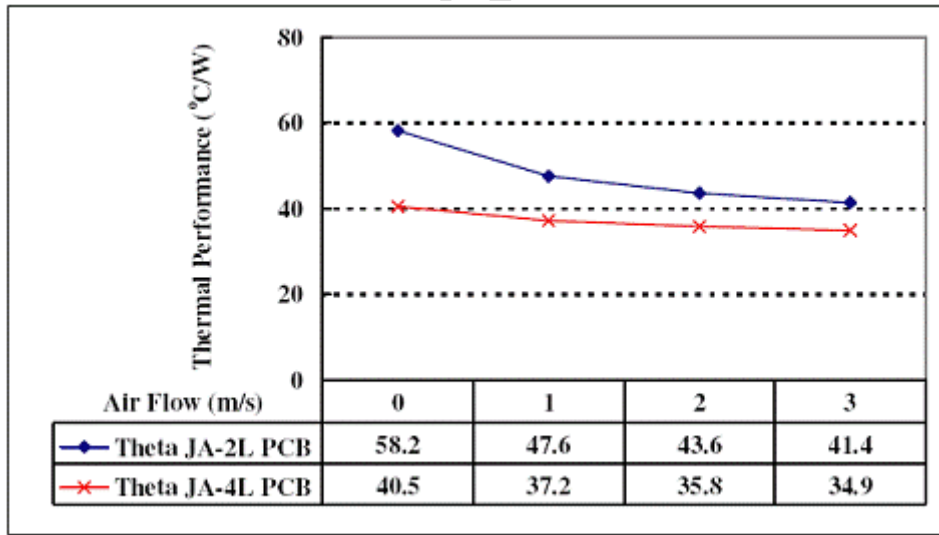

Thermal Performance of LQFP-128 under Forced Convection

## 7 PACKAGE DIMENSIONS

### 7.1 128L LQFP (14x14x1.4mm footprint)

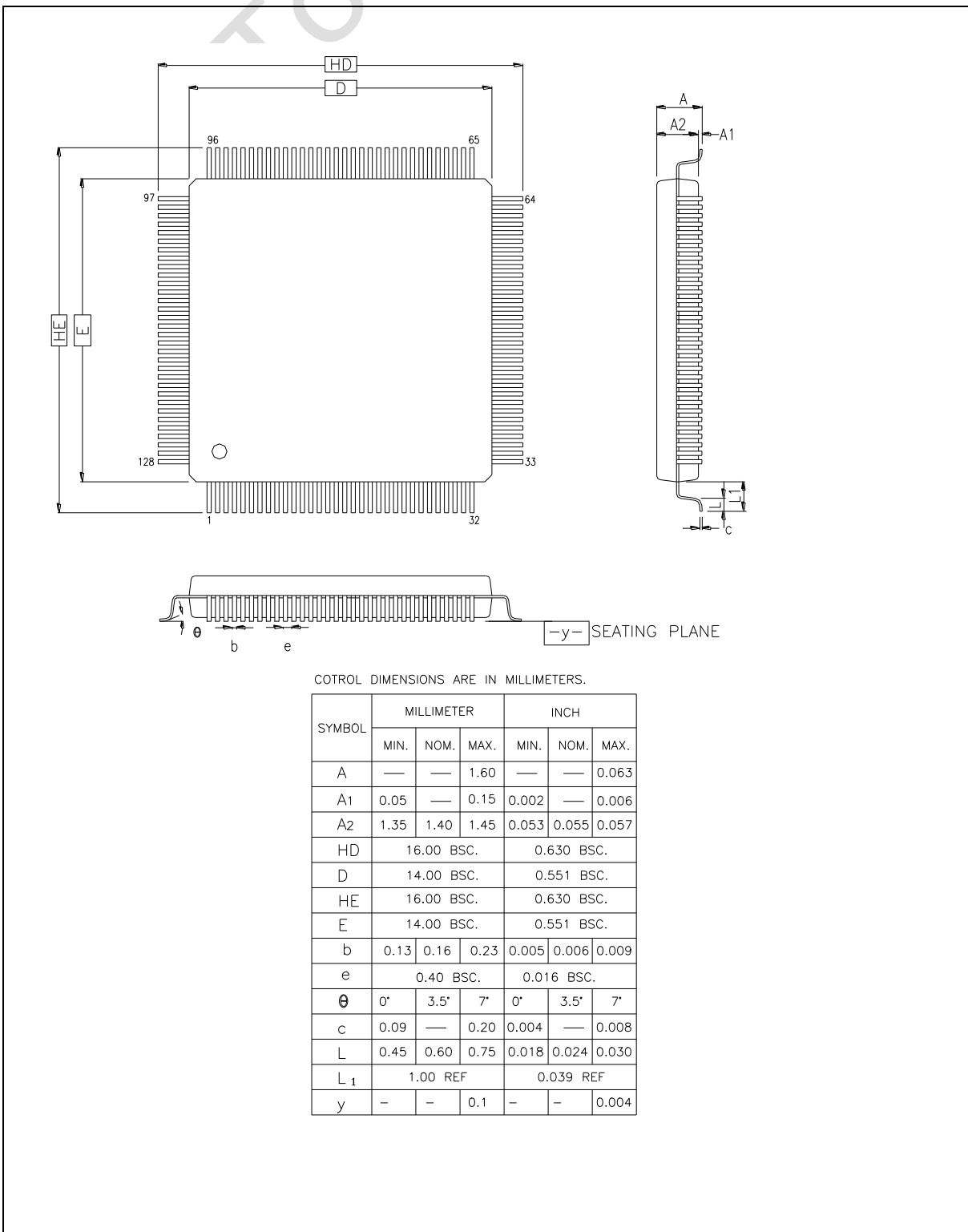

7.2 TQFP-64 (10X10X1.0mm footprint, 0.5mm pitch)

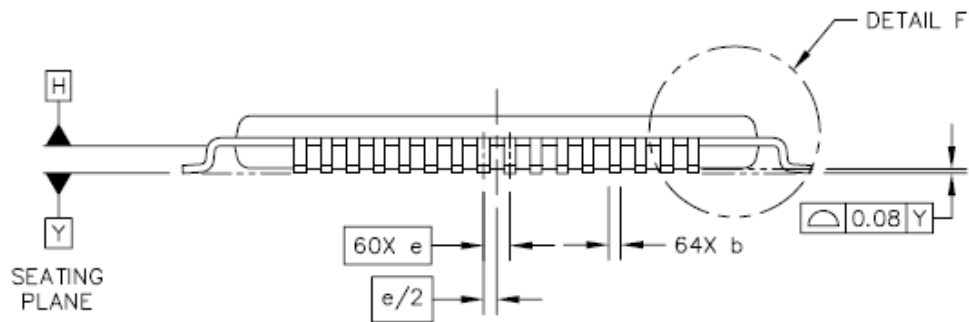
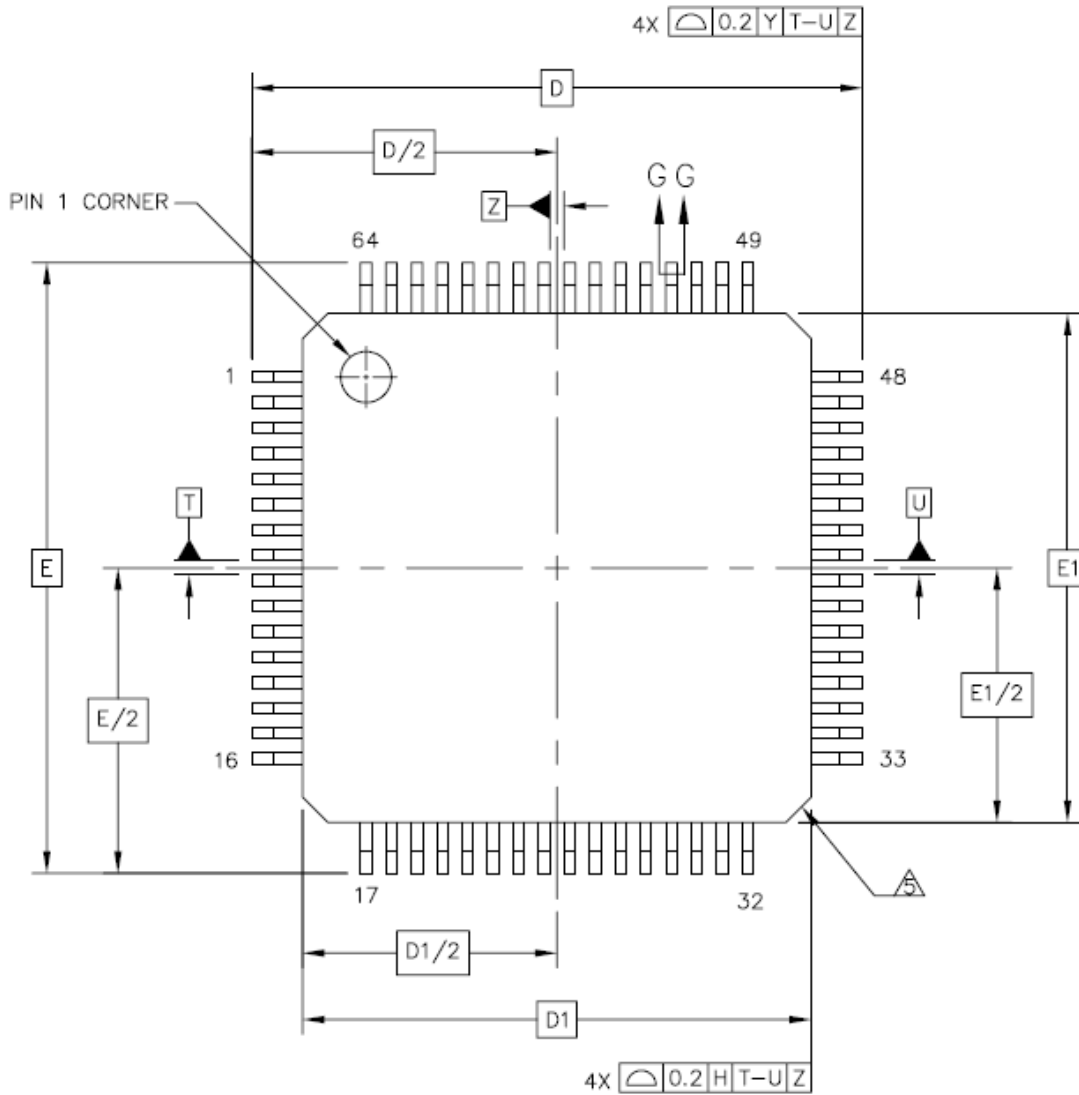

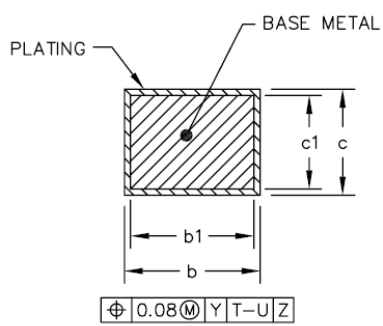
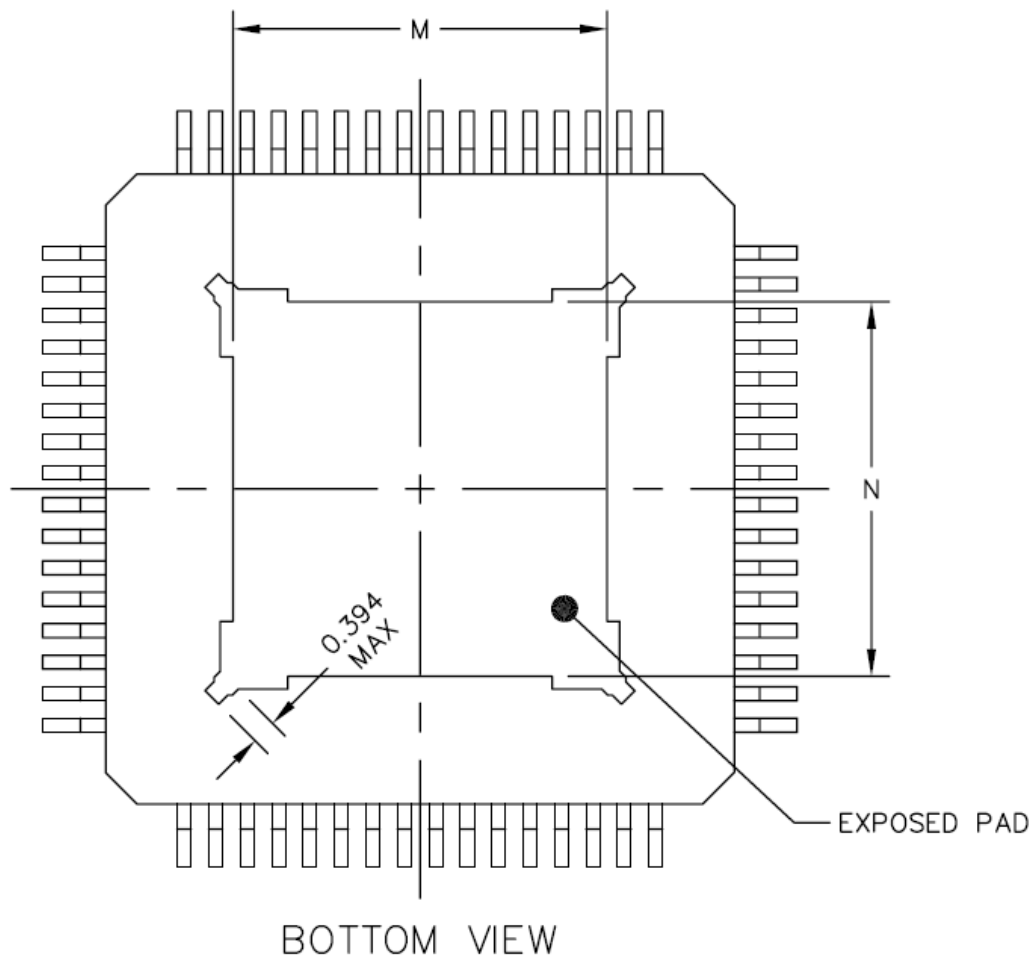

SECTION G-G

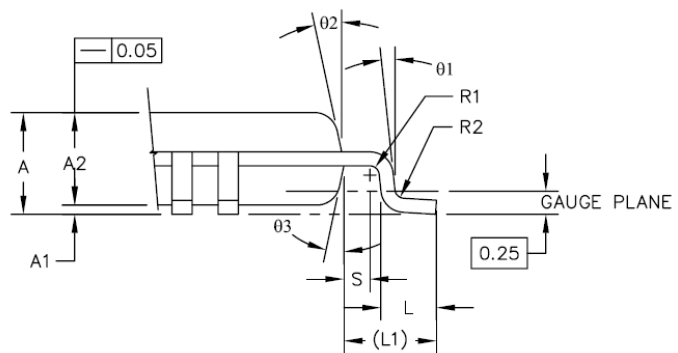

DETAIL F

DIM	MIN		MAX
A	---		1.2
A1	0.05		0.15
A2	0.95	1	1.05
b	0.17	0.22	0.27
b1	0.17	0.2	0.23
c	0.09		0.2
c1	0.09		0.16
D	12 BSC		
D1	10 BSC		
e	0.5 BSC		
E	12 BSC		
E1	10 BSC		
L	0.45	0.6	0.75

DIM	MIN		MAX
L1	1 REF		
R1	0.08	---	
R2	0.08	0.2	
S	0.2		---
$\theta$	0°	3.5°	7°
$\theta_1$	0°		---
$\theta_2$	11°	12°	13°
$\theta_3$	11°	12°	13°
M	5.85		6.05
N	5.85		6.05

UNIT: mm

COTROL DIMENSIONS ARE IN MILLIMETERS.

SYMBOL	MILLIMETER		
	MIN.	NOM.	MAX.
A	—	—	1.60
A1	0.05	—	0.15
A2	1.35	1.40	1.45
HD	16.00 BSC.		
D	14.00 BSC.		
HE	16.00 BSC.		
E	14.00 BSC.		
b	0.13	0.16	0.23
e	0.40 BSC.		
$\theta$	0°	3.5°	7°
c	0.09	—	0.20
L	0.45	0.60	0.75
L <sub>1</sub>	1.00 REF		
y	—	—	0.1

### 7.3 PCB Reflow Profile Suggestion

#### 7.3.1 Profile Setting Consideration

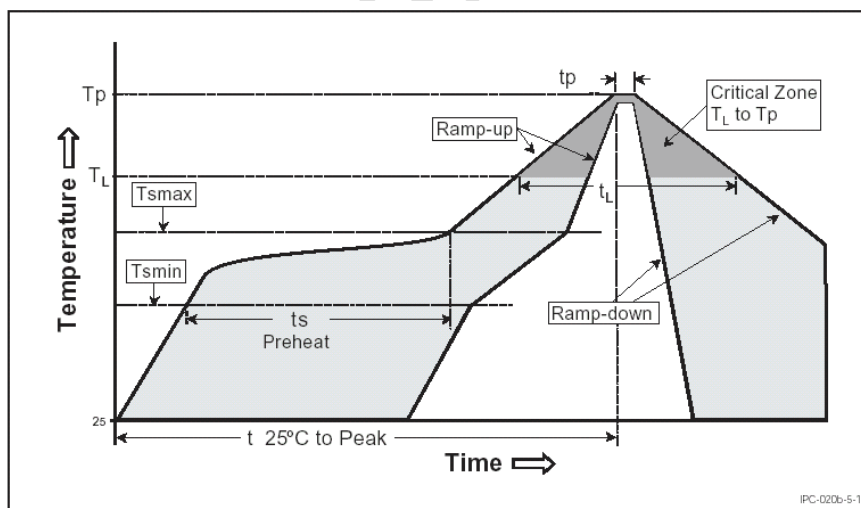

Profile Feature	Sn-Pb Eutectic Assembly		Pb-Free Assembly	
	Large Body	Small Body	Large Body	Small Body
Average ramp-up rate (T <sub>L</sub> to T <sub>p</sub> )	< 3°C/second		< 3°C/second	
Preheat				
-Temperature Min (T <sub>smmin</sub> )	100°C		150°C	
-Temperature Max (T <sub>smmax</sub> )	150°C		200°C	
-Time (min to max) (t <sub>s</sub> )	60-120 seconds		60-180 seconds	
Time maintained above:				
-Temperature (T <sub>L</sub> )	183°C		217°C	
-Time (t <sub>L</sub> )	60-150 seconds		60-150 seconds	
Peak Temperature (T <sub>p</sub> )	225+0/-5°C		245+5/-5°C	
Time within 5°C of actual Peak Temperature (t <sub>p</sub> )	10-20 seconds		10-30 seconds	
Ramp-down Rate	3°C/second max.		3°C/second max.	
Time 25°C to Peak Temperature	6 minutes max.		8 minutes max.	

Note: 1. All temperatures refer to topside of the package, measured on the package body surface.  
 2. Depends on other parts on board density and follower solder paste manufacturers's guideline

7.3.2 Profile Suggestion for N9H20 series

Reflow Profile for SiP on board Assembly

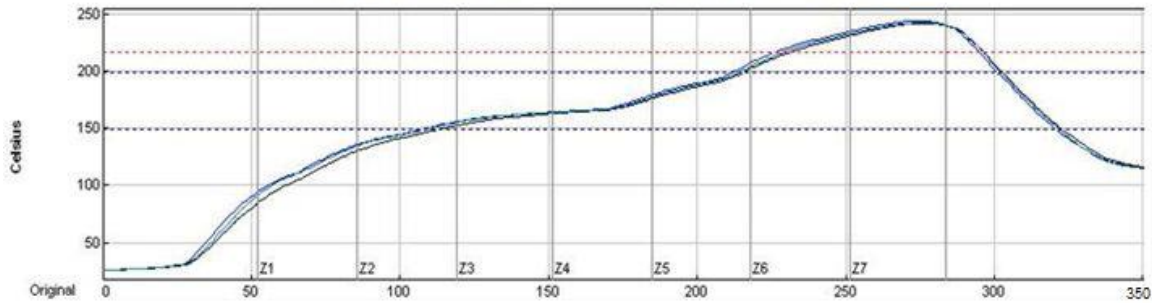

Preheat time	150°C—200°C: 105+/-15sec
Dwell time	Over 220°C: 70+5/-10 sec
Peak Temp	240 +10/-5°C
Ramp Up/Down Rate	Up: 3 +0/-2 °C / sec Down: 2 +0/-1°C / sec

## 8 REVISION HISTORY

Date	Revision	Description
2018, 05, 16	1.00	1. Preliminary version.
2018, 05, 16	1.10	2. Added N9H20R series

nuvoTon Confidential

### Important Notice

Nuvoton Products are neither intended nor warranted for usage in systems or equipment, any malfunction or failure of which may cause loss of human life, bodily injury or severe property damage. Such applications are deemed, "Insecure Usage".

Insecure usage includes, but is not limited to: equipment for surgical implementation, atomic energy control instruments, airplane or spaceship instruments, the control or operation of dynamic, brake or safety systems designed for vehicular use, traffic signal instruments, all types of safety devices, and other applications intended to support or sustain life.

All Insecure Usage shall be made at customer's risk, and in the event that third parties lay claims to Nuvoton as a result of customer's Insecure Usage, customer shall indemnify the damages and liabilities thus incurred by Nuvoton.

---

*Please note that all data and specifications are subject to change without notice.  
All the trademarks of products and companies mentioned in this datasheet belong to their respective owners.*