

GPS模块

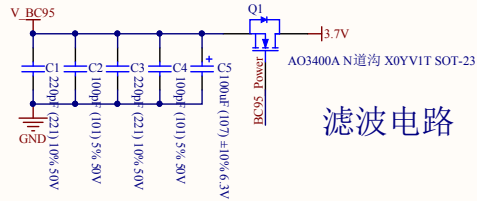

滤波电路



V\_BC95范围: 3.1V-4.2V,TYPE3.6V

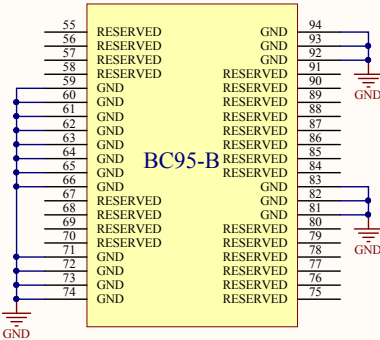

BC95-B

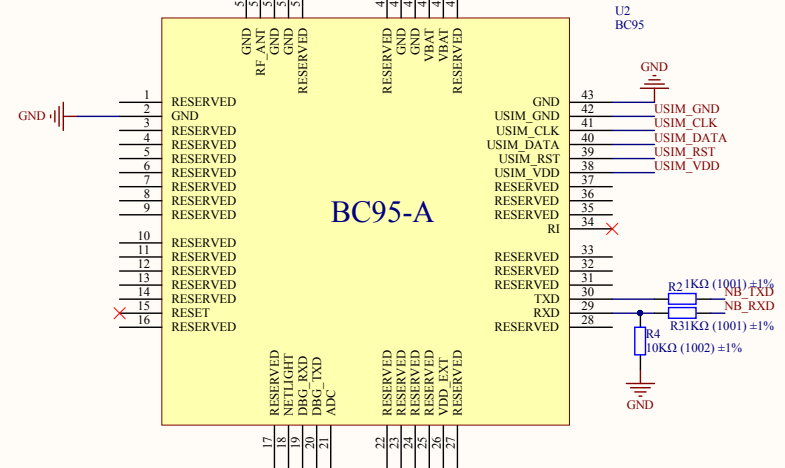

BC95-A

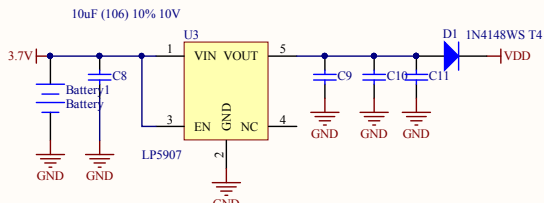

电源电路

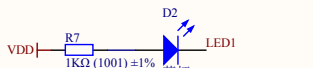
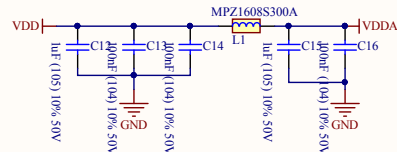

POWER\_STATE\_LED

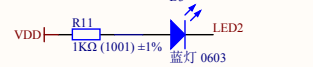

GPS\_STATE\_LED

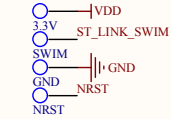

ST\_LINK下载接口

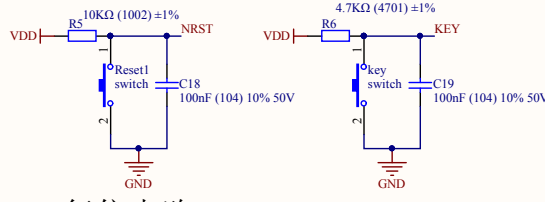

复位电路

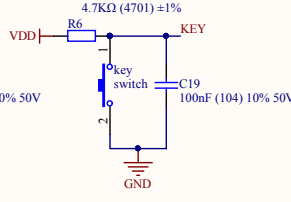

KEY

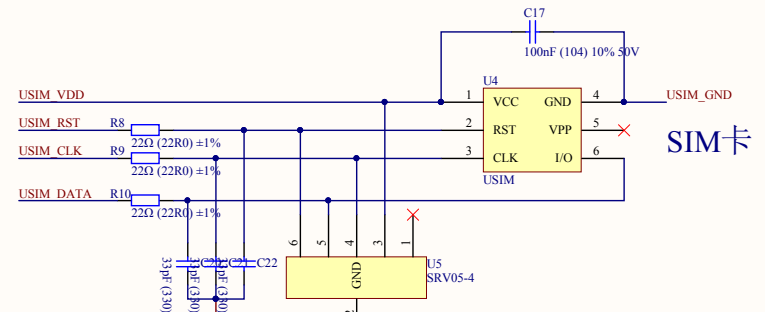

SIM卡

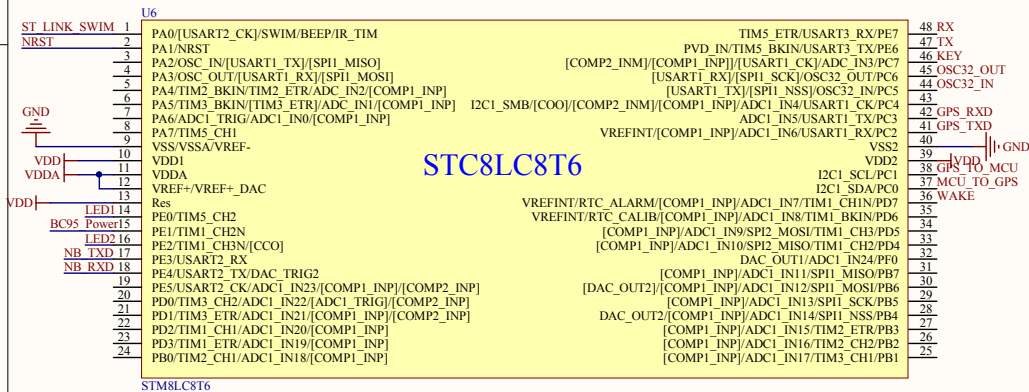

STM8LC8T6

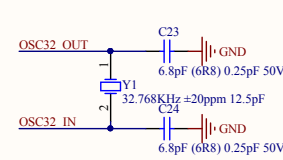

晶振电路



静电保护

NB-IOT模块电路

Title		
Size	Number	Revision
A3		
Date:	2018-06-12	Sheet of
File:	C:\Users\...\GPS定位_SchDoc	Drawn By: